



INNO-TECH
ideas for lighting

ADD
No4. Huanping Road, Gaoqiao District,
Pingdi Street, Longgang, Shenzhen,
Guangdong, China. 518000.

TEL
86-755-23763307

FAX
86-755-23763307

Email
info@itledlighting.com

Skype
ITLEDLIGHTING

Website
www.itledlighting.com

SHENZHEN INNO-TECH LIGHTING CO.,LIMITED

INNO-TECH
ideas for lighting



INDUSTRIAL
LED LIGHTING

www.itledlighting.com



Company Profile

SHENZHEN INNO-TECH LIGHTING CO., LIMITED is a professional manufacturer specializing in LED lighting product research&development, production and sales. Our product range covers LED UFO highbay, Led linear highbay, Led modular highbay, Led linear fixture, Panel light, Track light, down light, flood light, etc. Our marketing network has been expanded to over 150 Counties and regions including Europe, America, Oceania, Africa, Southeast Asia and the Middle East. We have established a reputation for providing high quality LED Lighting products, excellent customer service and sound technical advice. As a powerful team, all our sales are of over 8-year experience in LED lighting, able to answer any questions or assist with any orders. Besides, with more than eight years' experience in LED lighting industry, our top engineer is dedicated to develop high quality and high efficiency LED lighting products. Stay with us, make your life brighter & colorful.

PRODUCTS

INDUSTRIAL LED LIGHTING

LED INDUSTRIAL LIGHTING



ECO Series LED UFO highbay

100W/150W/200W/240W

PAGE 01



Smart LED UFO Highbay

100W/150W/200W

PAGE 03

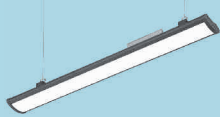

Eco Series LED Linear Highbay

60W/100W/150W/200W

PAGE 05

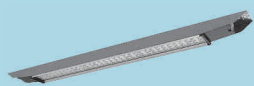

Linkable LED Industrial Linear Light

75W/90W/120W

PAGE 07



Sun Series IP69K LED Linkable Tri-Proof Light

20W/40W/50W/60W

PAGE 09



Tubular IP65 LED Tri-proof light

20W/40W/50W/60W

PAGE 11



Sun Series IP66 LED Linkable Tri-Proof Light, 100W Max

30W/40W/60W/80W/100W

PAGE 13



ECO Series IP66 LED Tri-proof Light

20W/40W/50W/60W

PAGE 15

PRODUCTS

INDUSTRIAL LED LIGHTING

LED INDUSTRIAL LIGHTING

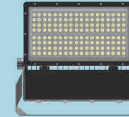

Sun Series LED Harbor Area Light, 600W Max

350W/500W/600W

PAGE 17

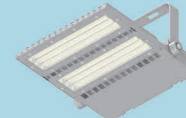

LED Stadium Area Light, 200W Max

75W/100W/150W/200W/240W

PAGE 19

LED OUTDOOR LIGHTING

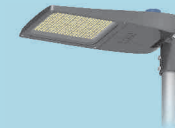

Smart LED Street Light

28W/38W/45W/55W/65W/75W/90W
105W/120W/130W/150W/160W/180W

PAGE 23

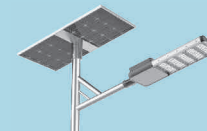

Semi-integrated Solar LED Lights

30W/40W/50W/60W/80W/100W/120W

PAGE 25

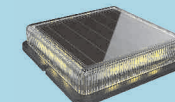

LED Solar Ground Light

0.6W

PAGE 27



LED Flood light

50W/80W/100W/150W/200W

PAGE 29



LED Flood Light Pro

50W/100W/150W/200W/300W

PAGE 31

PRODUCTS

INDUSTRIAL LED LIGHTING

LED OUTDOOR LIGHTING



LED Stadium Light

250W/500W/750W/1000W
1250W/1500W

PAGE 33

LED COMMERCIAL LIGHTING



LED office floor lamp

Indirect light 66W Direct light 34W

PAGE 35

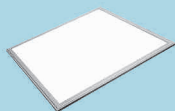

LED Square PANEL LIGHT

30W/40W/60W

PAGE 37



LED Round PANEL LIGHT

8W/15W/18W/22W

PAGE 39

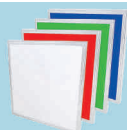

RGBW LED Panel Lights

45W/48W/53W

PAGE 41

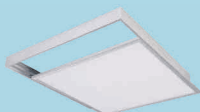

Screwless Surface Mounting Frame

integrated surface mounting frame
screwless recessed ceiling frame

PAGE 43



Moon Series Low UGR LED Down Light

6W/10W/15W/30W/40W

PAGE 45

PRODUCTS

INDUSTRIAL LED LIGHTING

LED COMMERCIAL LIGHTING



Moon series Glare free LED track light

20W/30W/40W

PAGE 47

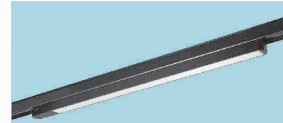

Eco Series LED Linear Track Light

20W/30W

PAGE 49



Continuous LED Linear Track Light

50W/60W

PAGE 51



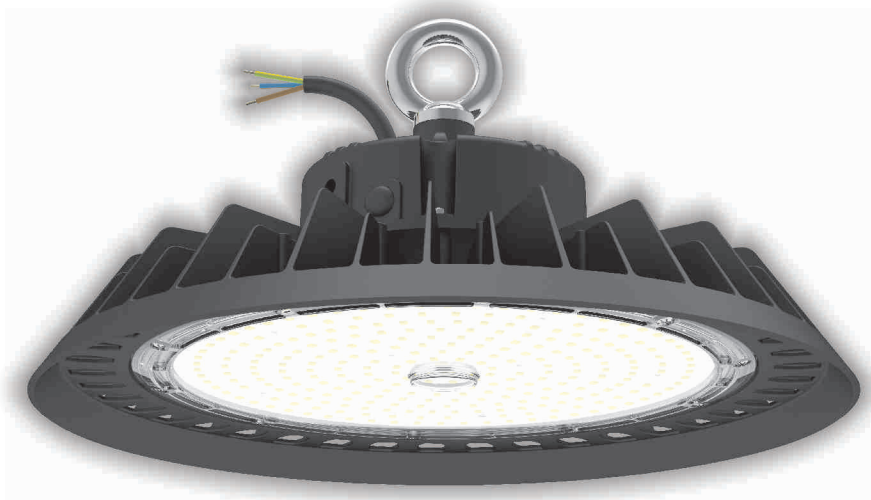

5 YEARS
WARRANTY

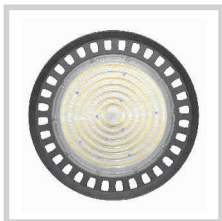

Excellent light control

- Wattage from 100W to 240W optional
- Power Selectable (Optional)
- High energy savings compared to systems with traditional discharge lamps
- Light-on-demand feature with optional motion sensor
- Robust design
- Emergency lighting with optional battery
- High visual comfort
- No hazardous materials
- Fast ROI thanks to long life span and reduced maintenance

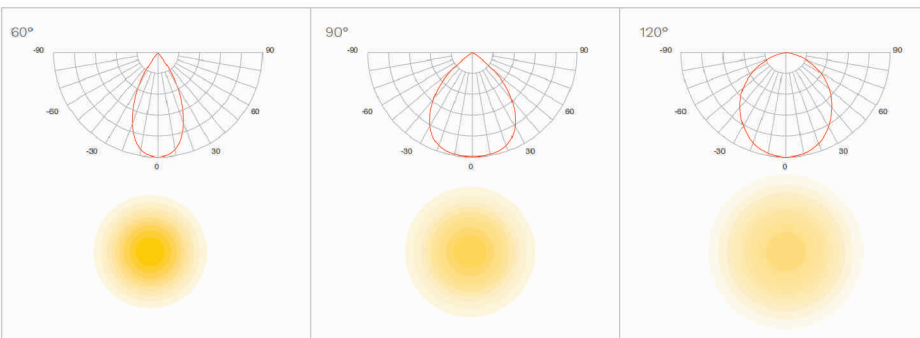

Features

- Patented design
- System efficiency up to 210LM/W
- Sosen Driver, PF>0.95
- 2835 SMD LED , CRI > 70 (80Ra optional)
- ADC12 aluminum die casting housing , perfect heat dissipation
- Available with 60°/ 90°/120° beam angle
- 3000K / 4000K / 5000K / 5700K / 6500K CCT
- Long life span , L70B10 > 100,000h

Applications

- Car parks
- Large areas
- Industrial halls&Warehouses
- Sport facilities

Specifications

| Model No | IT-HB100W | IT-HB150W | IT-HB200W | IT-HB240W |
|------------------------|------------------------------------|------------|------------|------------|
| Input Power | 100W | 150W | 200W | 240W |
| Dimension | Ø273*155mm | Ø308*160mm | Ø349*160mm | Ø400*172mm |
| CCT | 3000K/4000K/5000K/5700K/6500K | | | |
| CRI | Ra70 /Ra80 | | | |
| Dimming | 1-10V | | | |
| PF | >0.95 | | | |
| IP Grade | IP65 | | | |
| IK Rating | IK09 | | | |
| Input Voltage | AC200 - 277V 50/60Hz 1-10V dimming | | | |
| Lumens efficiency | 210lm/W,190lm/W,170lm/W,150lm/W | | | |
| Beam Angle | 60° /90°/120°/Reflector for option | | | |
| Working Temp& Humidity | -30°-45° | | | |
| Warranty | 5 years | | | |
| Lifespan | 50,000hours | | | |

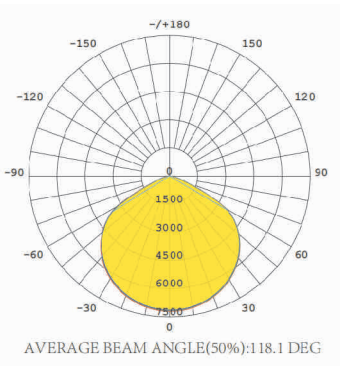
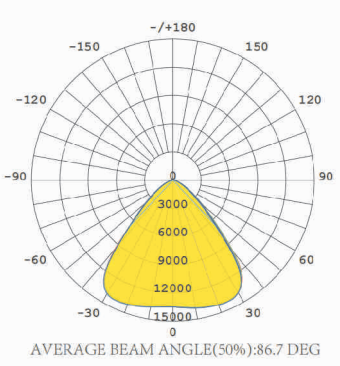
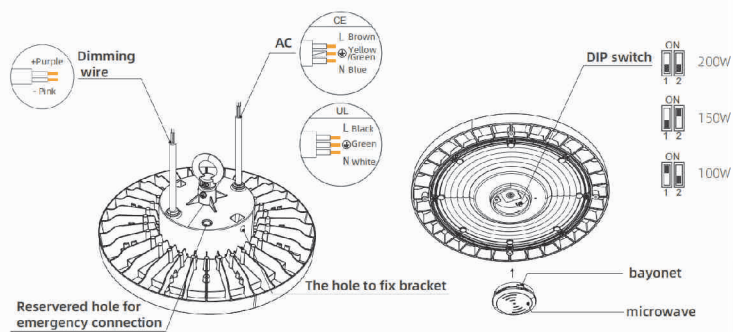

Smart LED UFO Highbay

Like warm and prompt

A periodic inspection and maintenance plan should be established in accordance with environmental and other relevant factors affecting the long term luminaire/equipment operation and secure mounting.

A secondary fall arrest kit is recommended for all suspended luminaires/equipment.

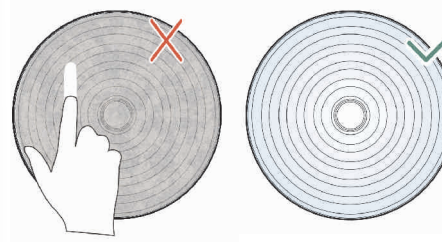

Features

- 200W(dimming to 150W/100W)
- 150LM/W(R80)/170LM/W(R80)/190LM/W(R70);
- 90°(Channel version: one Angle can cover more than 90% of the market)
- IP65 IK08
- power supply short circuit protected(SCP)/overvoltage protection(OVP)/over temperature protection(OTP);
- 0-10V/PWM, auxiliary power supply 200MA 12V;
- single lamp microwave sensors/group microwave constant illuminance controller are available in two standard configurations;
- Installation(suspending /wall mounted)Meet different customers's demands.

Applications

- Sports lighting
- Warehouse
- Storage

Specifications

| | |
|------------------------|-------------------------------------------------------------------------------------|
| Model No | IT-SHB-200W |
| Input Power | 200W(dimming to 150W/100W) |
| Dimension | Ø300*97 |
| CCT | 4000K/5000K/5700K |
| CRI | Ra70 /Ra80 |
| Dimming | 3 in 1 dimming (PWM, 0-10V, resistor) , Power dial or internal microwave controller |
| PF | >0.95 |
| IP Grade | IP65 |
| Input Voltage | 100-277VAC |
| Lumens efficiency | Ra80/150lm/w±10% Ra80 /170lm/w±10% Ra70 /190lm/w±10% |
| Beam Angle | 90°/ 120° |
| Working Temp& Humidity | -40°-50° & 20~95%RH No condensation |
| Surge | 6KV / 10KV |
| Installation Mode | Suspending/wall mounted(reference the instruction) |
| Warranty | 5 years |
| Lifespan | 50,000hours |



5 YEARS
WARRANTY



Eco Series LED Linear Highbay

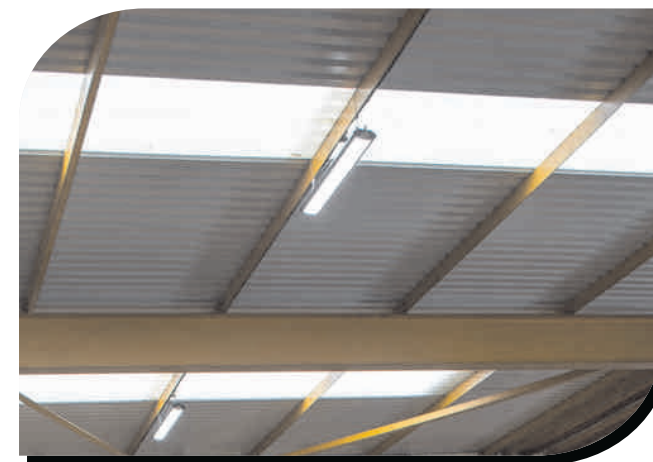

Features

- Aluminum design with excellent heat dissipation
- Environmentally friendly, no mercury, No UV, No IR
- 180 degree with wide lighting area
- IP65 waterproof,dust, corrosion and pressure-proof; for indoor use
- Suitable for 6 to 12meter height.
- High quality Meanwell driver.
- 5 Year warranty.on complete fixture. (LED's, Driver, & Housing)"

Applications

- Sports lighting
- Warehouse
- Storage

Specifications

| Model No | IT-H60W | IT-H100W | IT-H150W | IT-H200W |
|------------------------|--------------------------------------|--------------|---------------|---------------|
| Input Power | 60W | 100W | 150W | 200W |
| Dimension | 900*150*72mm | 900*150*72mm | 1200*150*72mm | 1500*150*72mm |
| CCT | 3000K/4000K/5000K/5700K | | | |
| CRI | Ra70 /Ra80 | | | |
| Dimming | 1-10V dimming / Dali dimming | | | |
| PF | >0.95 | | | |
| IP Grade | IP65 | | | |
| Input Voltage | 100-277VAC | | | |
| Lumens efficiency | 130lm/w or 150lm/w | | | |
| Beam Angle | 180° | | | |
| Working Temp& Humidity | -40°-45° & 20~95% RH No condensation | | | |
| Installation Mode | Rope/Bracket Mount | | | |
| Warranty | 5 years | | | |
| Lifespan | 50,000hours | | | |

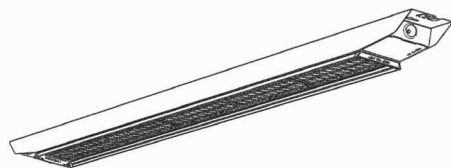

5 YEARS
WARRANTY

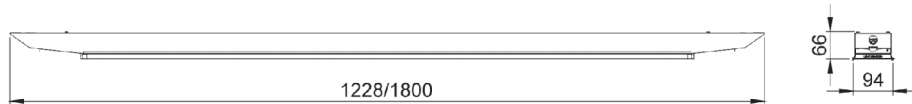
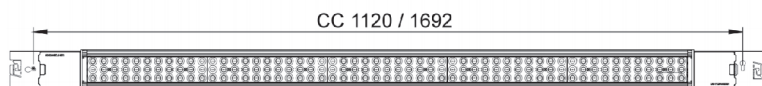
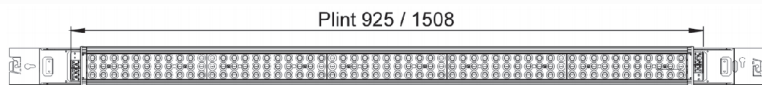

Excellent light control

With individual lens technology for each diode, L23 can guarantee optimal light comfort regardless of application area. L23 is available in several different light distributions and lumen outputs, which makes it adaptable from low to high bay installations.

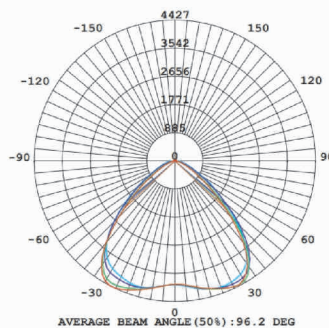

Linkable LED Industrial Linear Light

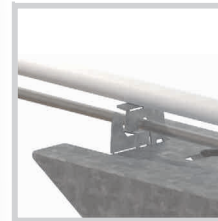

Features

- Osram Driver
- Linkable available
- 30° / 60° / 90° Beam Angle
- 150~160lm/W CRI80
- Entire light engine is replaceable
- For Warehouse, Production, Sports Facility, Industry

Applications

- Gym lighting
- Garage lighting
- Workshop lighting
- Warehouse lighting

Specifications

| Model No | IT-L23-75W | IT-L23-90W | IT-L23-120W |
|------------------------|--------------------------------------|--------------|--------------|
| Input Power | 75W | 90W | 120W |
| Dimension | 1230*94*66mm | 1800*94*66mm | 1800*94*66mm |
| CCT | 3000K/4000K/5000K/6000K | | |
| CRI | >80 | | |
| Dimming | 1-10V dimming / Dali dimming | | |
| PF | >0.95 | | |
| IP Grade | IP23 | | |
| Input Voltage | 200~240VAC | | |
| Lumens efficiency | 150lm/W+5% | | |
| Beam Angle | 30° / 60° / 90° | | |
| Working Temp& Humidity | -20°-45° & 20~95% RH No condensation | | |
| Installation Mode | Rope/Bracket Mount | | |
| Warranty | 5 years | | |
| Lifespan | 100,000hours | | |

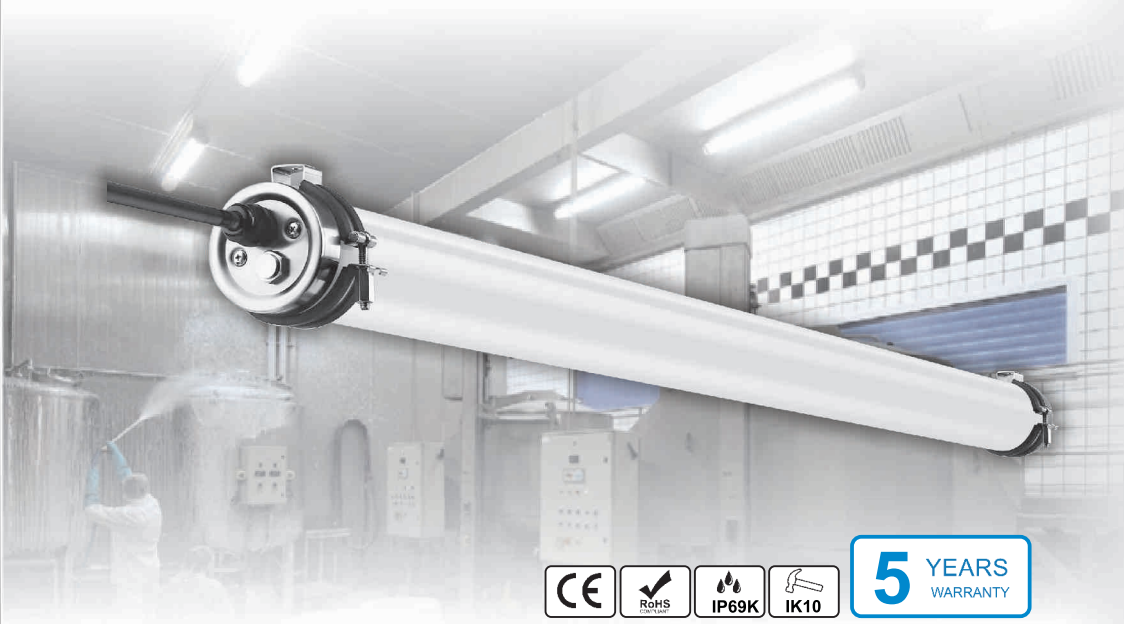

Single installation

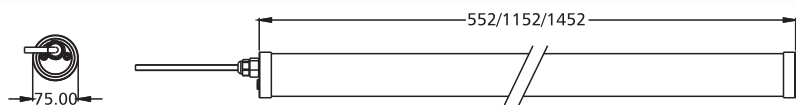

Linkable Installation

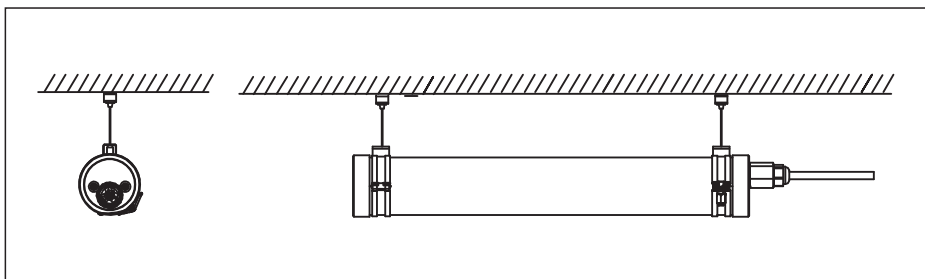
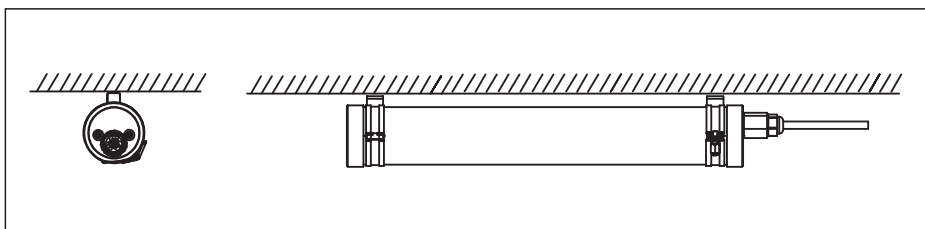
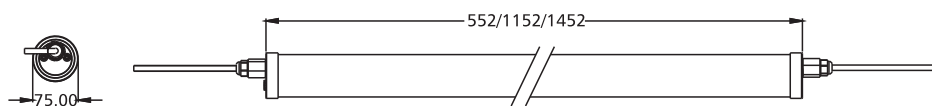

Sun Series IP69K LED Linkable Tri-Proof Light



Features

- IP69K / Ip68
- PMMA IK08 / PC Ik10
- Anti-ammonia
- Against water pressure of 100bar(1450psi) and temperature of 80°C
- System efficiency up to 130lm/W & 150lm/W option
- High CRI >80
- UGR<19 is available
- DMX Function is available
- Environmentally friendly, no mercury, No UV, No IR
- Wide beam angle 120°
- Energy Efficiency Grade: A+
- Quick Start instant 100% luminous flux
- 5 Year Warranty on complete fixture. (LED's, Driver, & Housing)
- Certificate: CE,RoHS,CB,ENEC ,SAA Certified
- Surface Mount or Suspended
- Standard material for end caps, breather, surface mounting bracket is 304 stainless steel, 316 material is available for option.

Applications

- Food Processing
- Farm Lighting
- Poultry Lighting
- Paper Plant

Specifications

| Model No | IT-L9-2F-20W | IT-L9-4F-40W | IT-L9-5F-50W | IT-L9-5F-60W |
|-------------------|-----------------------|--------------|--------------|--------------|
| Input Power | 20W | 40W | 50W | 60W |
| Dimension | 552*Ø75mm | 1152*Ø75mm | 1452*Ø75mm | 1452*Ø75mm |
| CCT | 4000K / 5000K / 6000K | | | |
| CRI | >80 | | | |
| Dimming | 1-10V or Dali dimming | | | |
| PF | >0.9 | | | |
| IP Grade | IP69K | | | |
| Input Voltage | AC 220-240V (50/60Hz) | | | |
| Lumens efficiency | 130lm/w or 150lm/w | | | |
| Beam Angle | 120° | | | |
| Working Temp | -20°-45°C | | | |
| Leaking voltage | <10V | | | |
| Inrush current | <14A | | | |
| Warranty | 5 years | | | |
| Lifespan | 54,000hours | | | |

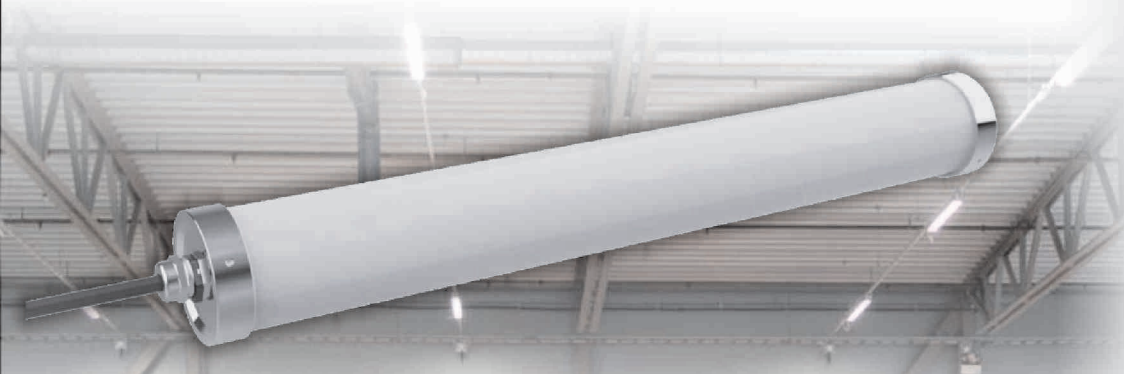

5 YEARS
WARRANTY

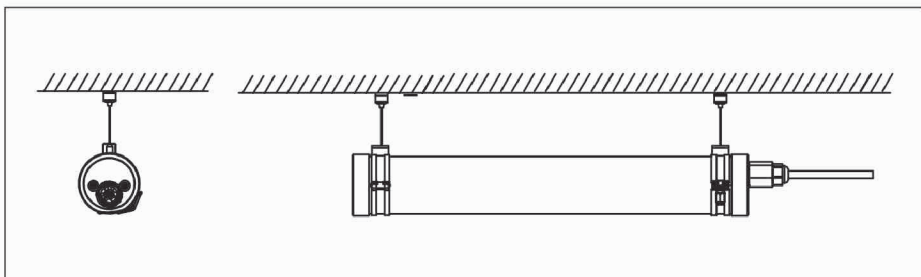
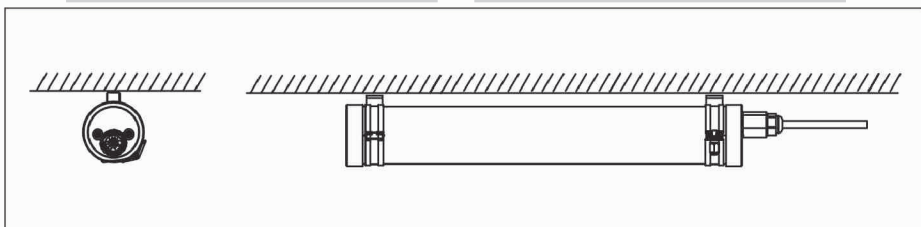
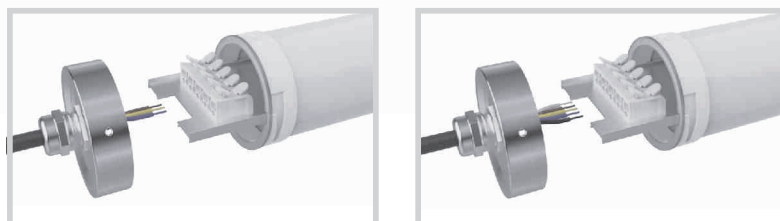
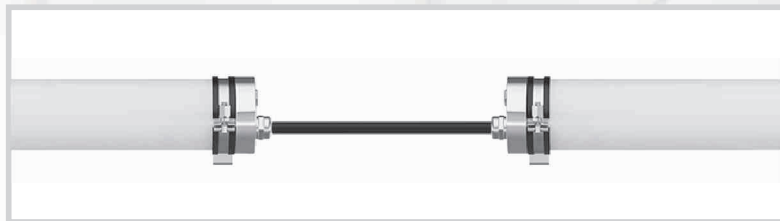

Tubular IP65 LED Tri-proof light

Features

- Anti-ammonia
- Against water pressure of 100bar(1450psi) and temperature of 80°C
- System efficiency up to 130lm/W & 150lm/W option
- DMX Function is available
- Sensor & Emergency function optional
- Wide beam angle 120°
- With IP68 fast linkable connectors
- Quick Start instant 100% luminous flux
- 5 Year Warranty on complete fixture. (LED's, Driver, & Housing)

Applications

- Food Processing
- Farm Lighting
- Poultry Lighting
- Paper Plant

Specifications

| | | | |
|-------------------------------|----------------------------------------------------|--------------|----------------|
| Product Code | IT-L9-2F-20W-E | IT-L9-4F-40W | IT-L9-5F-60W-E |
| Power | 20W | 40W | 60W |
| Wattage Adjustable | 13/16/20W | 25/30/35/40W | 40/50/60W |
| Input Voltage | 200-240VAC/100-277VAC (50/60HZ) | | |
| Input Current | 0.09A@220VAC | 0.19A@220VAC | 0.28A@220VAC |
| PF | 0.90@220VAC | | |
| Dimming Option | 0-10V/Dali | | |
| CCT | 3000K/4000K/5000K/6000K | | |
| Ra > 80 | Luminous Flux | 5200Lm±5% | |
| | Efficiency | 2600Lm±5% | 130Lm/W±5% |
| Ra > 80 | Luminous Flux | 6000Lm/W±5% | |
| | Efficiency | 3000Lm/W±5% | 150Lm/W±5% |
| LED Brand | Lumileds/Hongli 2835 | | |
| Beam Angle | 120° | | |
| Operation Temp | -20°C~+40°C | | |
| Storage Temp | -20°C~+60°C | | |
| Life Span | Ta 40°C L70>54000Hours | | |
| IP Class | IP65 | | |
| IK Class | PMMA IK08/PC IK10 | | |
| Certificate | CE, RoHs | | |
| Material | PC/PMMA Housing & 304/316 Stainless Steel End Caps | | |
| Product Size (mm) | | 75*1152 | |
| Packing Size (mm) | 730*260*260 | 1330*260*180 | 1630*260*180 |
| Quantity/carton | 9PCS | 6PCS | 6PCS |
| Gross weight (kg) ±0.3 | 12 | 15 | 23 |
| Installation mode | Surface Mount/Suspension Mount | | |



5 YEARS
WARRANTY

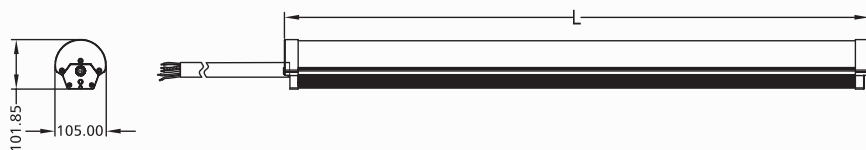
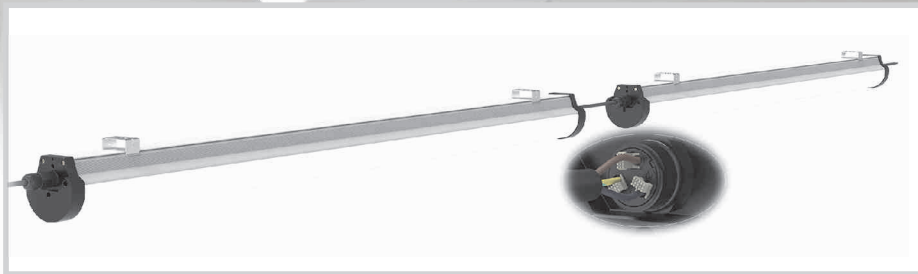

Sun Series IP66 LED Linkable Tri-Proof Light, 100W Max

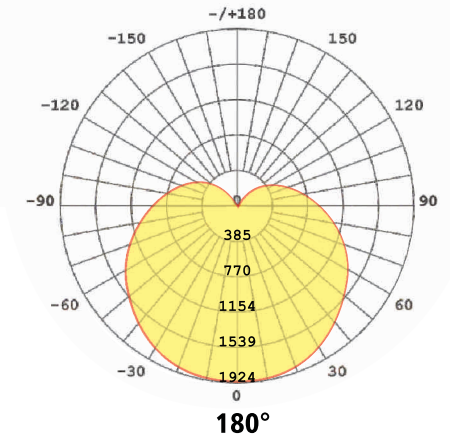
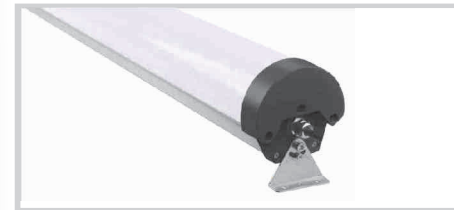
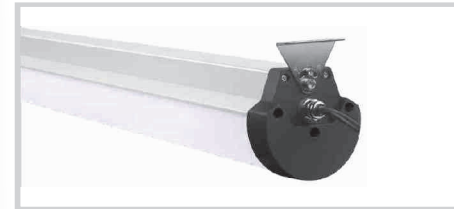

Features

- High Output LED's, up to 160m/W, LM80 light source
- Environmentally friendly, no mercury, No UV, No IR
- Linkable Option (Customize cable length)
- IP66 waterproof, dust, corrosion and pressure-proof; for indoor & outdoor use
- Energy Efficiency Grade: A+
- Quick Start instant 100% luminous flux
- 5 Year Warranty on complete fixture. (LED's, Driver, & Housing)

Applications

- Car parking Lighting
- School Lighting
- Workshops
- Supermarkets
- Warehouse
- Storage

Specifications

| Model No | IT-LF-30W | IT-LF-40W | IT-LF-60W | IT-LF-80W | IT-LF-100W |
|-------------------------|--------------------------------------|----------------|----------------|----------------|----------------|
| Input Power | 30W | 40W | 60W | 80W | 100W |
| Dimension | 600*105*127mm | 1200*105*127mm | 1200*105*127mm | 1500*105*127mm | 1500*105*127mm |
| CCT | 3000K / 4000K / 5000K / 5700K | | | | |
| CRI | Ra70 / Ra80 | | | | |
| Dimming | 1-10V dimming / Dali dimming | | | | |
| PF | >0.95 | | | | |
| IP Grade | IP66 | | | | |
| Input Voltage | 100-277VAC 50/60Hz | | | | |
| Lumens efficiency | 130lm/w or 150lm/w | | | | |
| Beam Angle | 180° | | | | |
| Working Temp & Humidity | -20°-45° & 20~95% RH No condensation | | | | |
| Surge | 6KV / 10KV | | | | |
| Installation Mode | Rope/Bracket Mount | | | | |
| Warranty | 5 years | | | | |
| Lifespan | 50,000 hours | | | | |



5 YEARS
WARRANTY

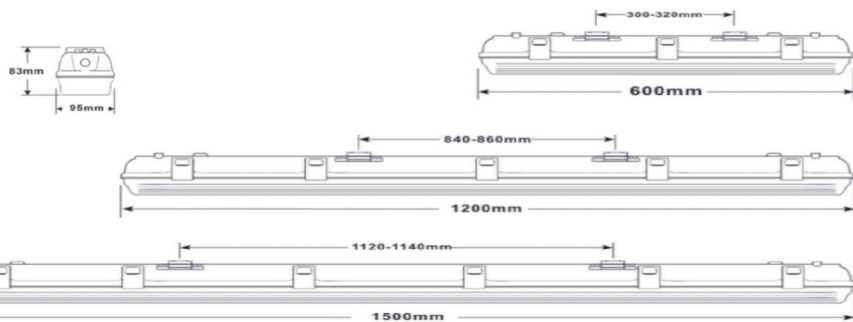
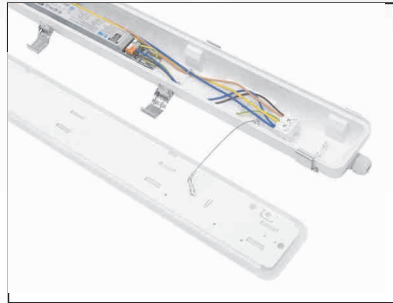

ECO Series IP66 LED Tri-proof Light

Suspending

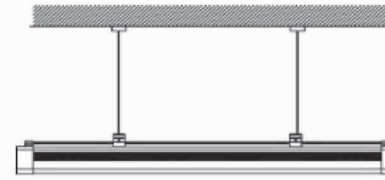

Ceiling Mounted

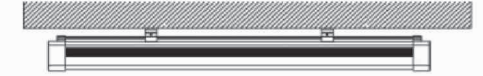

Features

- IP66, Ik10
- Stainless steel clips & safety rope
- 5x2.5mm² through wiring optional (Standard is with 3*0.75mm² for non dimming ,5*1mm² for dimming)
- Boke isolated flicker free driver ,100,000 hours lifespan .
- 150lm/W system efficiency, CRI80(Philips leds)
- PC cover + PC base(V2)
- Self-test emergency with LiFePO4 battery option
- Microwave sensor options(wireless control)
- Ambient Temperatures: -20 to +40 degrees
- 5 Year Warranty, CE, RoHs Certified
- Options: 1-10V, Motion Sensor, DALI, Emergency
- Surface Mount or Suspension mount

Applications

- Car parking Lighting
- School Lighting
- Workshops
- Supermarket
- Warehouse
- Storage

Specifications

| Model No | IT-LTF-20W | IT-LTF-4F-40W | IT-LTF-5F-50W | IT-LTF-5F-60W |
|-------------------|-------------------------|---------------|---------------|---------------|
| Input Power | 20W | 40W | 50W | 60W |
| Dimension | 600*95*83mm | 1200*95*83mm | 1500*95*83mm | 1500*95*83mm |
| Luminous | 2800~3000lm | 5600~6000lm | 7000~7500lm | 8400~9000lm |
| CCT | 3000K/4000K/5000K/6000K | | | |
| CRI | >80 | | | |
| PF | >0.9 | | | |
| IP Grade | IP66 | | | |
| Input Voltage | 200-240VAC | | | |
| PC Cover | Milky | | | |
| Lumens efficiency | 150lm/W±5% | | | |
| Beam Angle | 120° | | | |
| Working Temp | -20°-40° | | | |
| Warranty | 5 years | | | |
| Lifespan | L70>54,000hrs | | | |

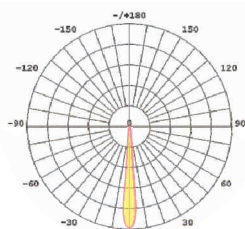
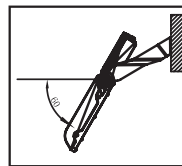
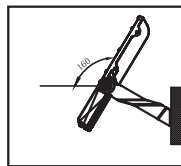
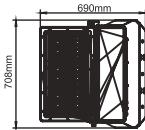
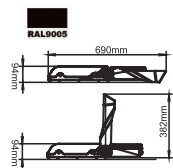
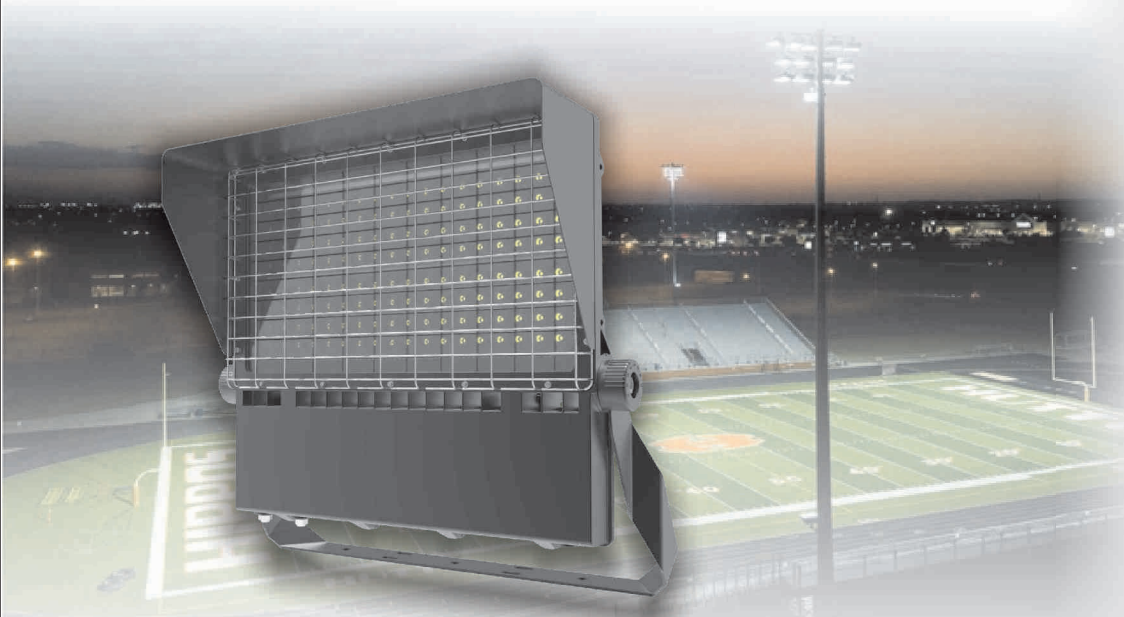

10°

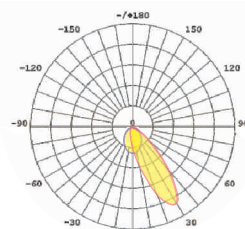

ANB

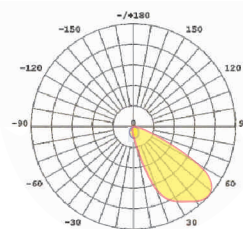

AWB

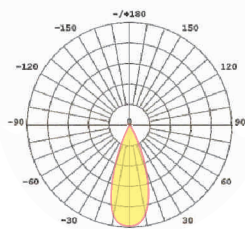

36°

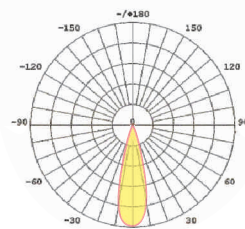

24°

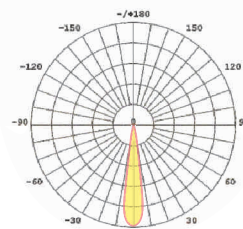

15°

Sun Series LED Harbor Area Light, 600W Max

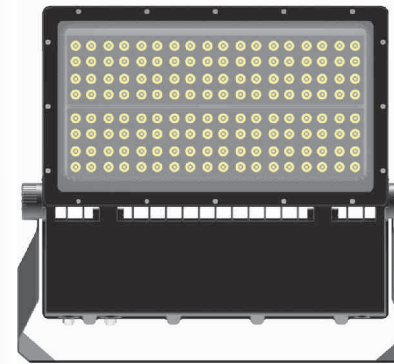

- Suitable for Marine climate, Corrosion resistance more than 10 years.

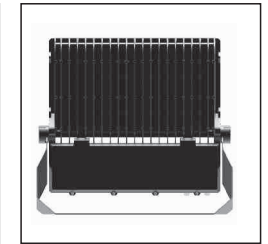

Features

- Nichia & Meanwell driver ,high quality Assurance
- Various optical designs to fit different applications.
- Anti-glare from light source to overall lamp specially for sports area.
- Meets 3G vibration standards and vibration frequency of 100,000 times.
- High salt spray resistance and anti-ultraviolet procession meet the needs of special places such as seaside,dock, iron tower, stadium and high pole.

Applications

- Sports lighting
- Harbour
- Dock
- Mining area
- Square
- Any outdoor application

Specifications

| Model No | IT-LHAL350W | IT-LHAL500W | IT-LHAL600W |
|------------------------|-----------------------------------------------|-------------|-------------|
| Input Power | 350W | 500W | 600W |
| Dimension | 690*708*94 | 690*708*94 | 690*708*94 |
| CCT | 2700k/4000K/5000K/5700K | | |
| CRI | Ra70 /Ra80 | | |
| LED BRAND | Nichia , Cree | | |
| Dimming | 3 in 1 dimming (PWM, 1-10V, Resistor) or Dali | | |
| PF | >0.95 | | |
| IP Grade | IP66 | | |
| Input Voltage | 90-305VAC | | |
| Lumens efficiency | 100-150Lm/W±10% | | |
| Beam Angle | 10° , 15° , 24° , 36° ,AWB , ANB | | |
| Working Temp& Humidity | -40°-45° & 20~95%RH No condensation | | |
| Surge | 6KV / 10KV | | |
| Installation Mode | Bracket Mount | | |
| Warranty | 5 years | | |
| Lifespan | 50,000hours | | |

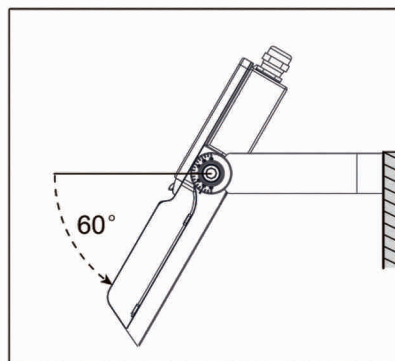
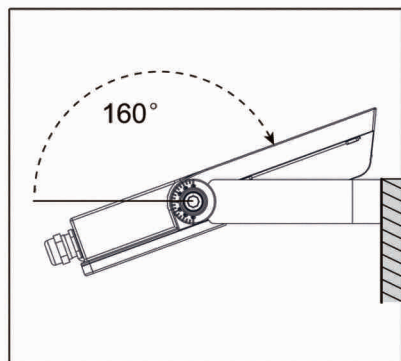
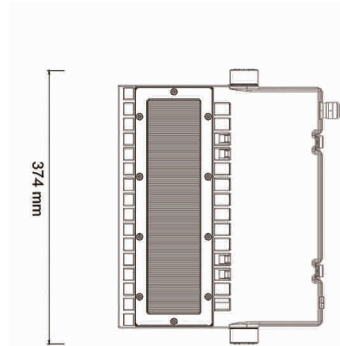
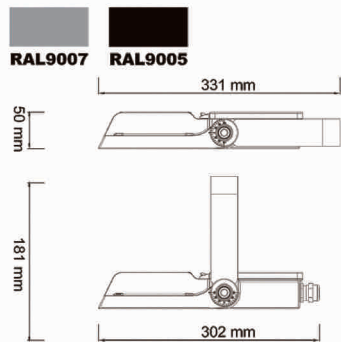
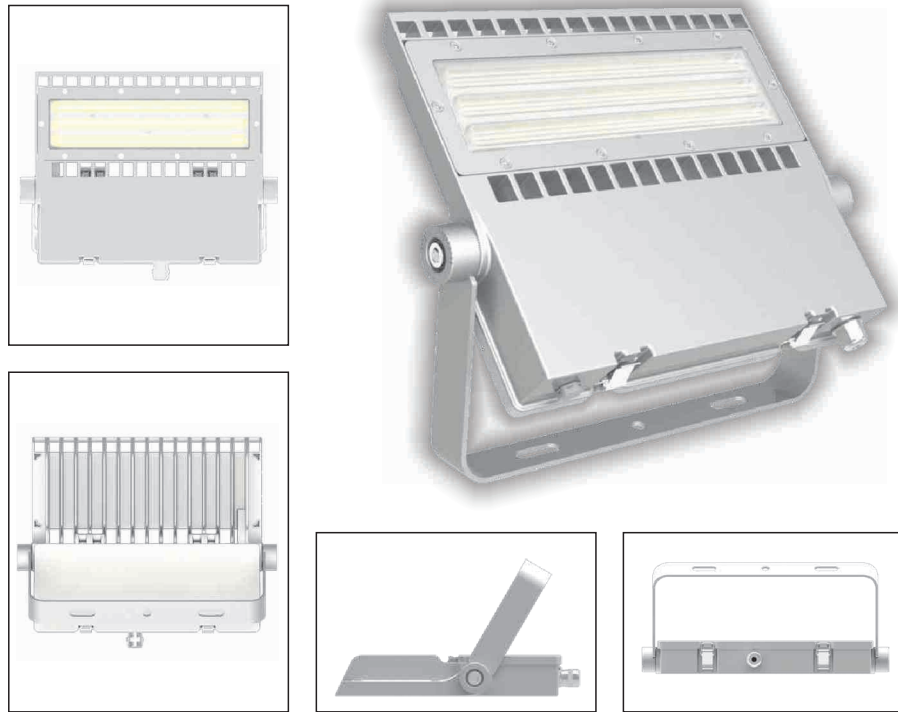

LED Stadium Area Light, 200W Max

Features

- Nichia & Meanwell driver ,high quality Assurance
- Special designed for high-end Area lighting
- Special optical design to make perfect lighting performance.
- Unique clips design on driver box, easy maintenance
- Up to 140lm/w ,energy saving
- 5 years warranty

Applications

- Sports lighting
- Billboard
- Road Lighting
- Any outdoor application

Specifications

| Product Code | IT-LAL-75W | IT-LAL-100W | IT-LAL-150W | |
|--------------------------|--------------------------------------------------------|---------------|---------------|---------------|
| Power | 75W | 100W | 150W | |
| Input Voltage | 90-305VAC | | | |
| Input Current | 0.34A@220VAC | 0.45A@220VAC | 0.68A@220VAC | |
| PF | 0.90@220VAC | | | |
| DC output voltage | 48V | | | |
| DC output current | 1.4A | 1.9A | 2.9A | |
| Dimming(Optional) | 3 in 1 dimming(PWM, 0-10V, Resistor)Dali | | | |
| CCT | 3000K/4000K/5000K/5700K | | | |
| Ra > 80,5000K | Luminous Flux | 9750Lm/W±10% | 13000Lm/W±10% | 19500Lm/W±10% |
| | Efficiency | 130Lm/W±10% | | |
| Ra > 70,5000K | Luminous Flux | 10500Lm/W±10% | 14000Lm/W±10% | 21000Lm/W±10% |
| | Efficiency | 140Lm/W±10% | | |
| LED Brand | Nichia 3030 | | | |
| Beam Angle | Asymmetric and symmetric light | | | |
| Operation Temp | -40°C ~ +45°C | | | |
| Storage Temp | -40°C ~ +85°C | | | |
| Life Span | 45°C 50000Hours | | | |
| IP Class | IP66 | | | |
| IK Class | IK10 | | | |
| Certificate | CE, RoHs | | | |
| Lamp Body Color | Cray(default with RAL9007)、Black(optional for RAL9005) | | | |
| Product Size (mm) | 331*374*50 | | | |
| Net weight (kg) ±0.1 | 4.58 | 4.46 | 4.76 | |
| Packing Size (mm) | 430*370*76 | | | |
| Gross weight (kg) ±0.1 | 4.98 | 5.03 | 5.16 | |
| Total Size (mm) (2pcs) | 445*328*390 | | | |
| Total weight (2pcs) ±0.2 | 20.68 | 20.88 | 21.4 | |
| Installation mode | Bracket Mount | | | |

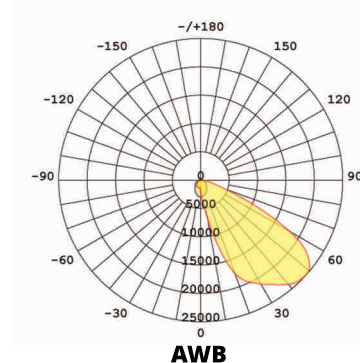
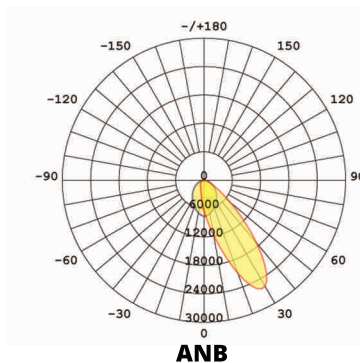
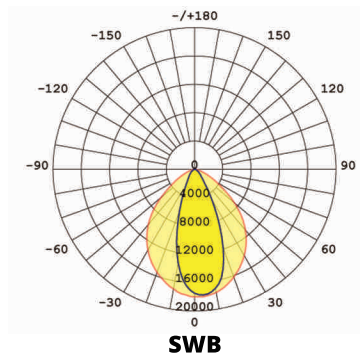
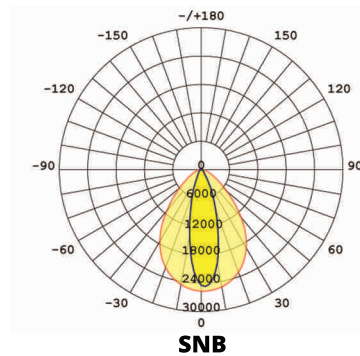
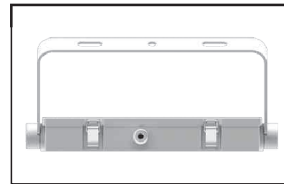
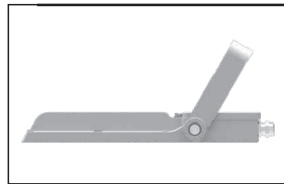
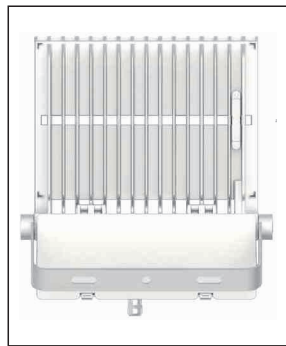
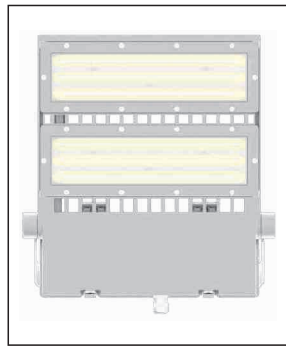

LED Stadium Area Light, 200W Max

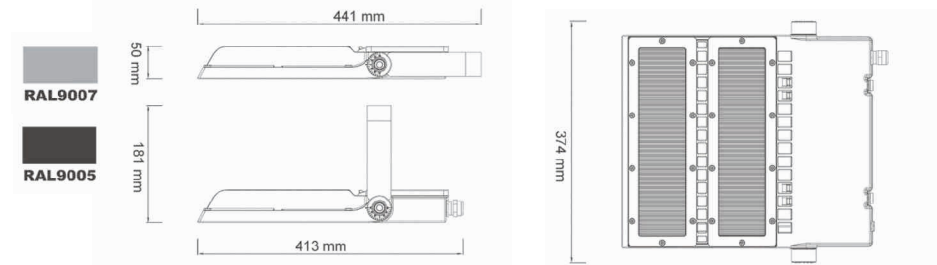

Specifications

| | | |
|---------------------------------|--------------------------------------------------------|---------------|
| Product Code | IT-LAL-200W | IT-LAL-240W |
| Power | 200W | 240W |
| Input Voltage | 90-305VAC | |
| Input Current | 0.91A@220VAC | 1.10A@220VAC |
| PF | 0.90@220VAC | |
| DC output voltage | 48V | |
| DC output current | 3.9A | 4.65A |
| Dimming(Optional) | 3 in 1 dimming(PWM, 0-10V, Resistor)Dali | |
| CCT | 3000K/4000K/5000K/5700K | |
| Ra > 80,5000K | Luminous Flux | 26000Lm/W±10% |
| | Efficiency | 130Lm/W±10% |
| Ra > 70,5000K | Luminous Flux | 28000Lm/W±10% |
| | Efficiency | 140Lm/W±10% |
| LED Brand | Nichia 3030 | |
| Beam Angle | Asymmetric and symmetric light | |
| Operation Temp | -40°C~+45°C | |
| Storage Temp | -40°C~+85°C | |
| Life Span | 45°C 50000Hours | |
| IP Class | IP66 | |
| IK Class | IK10 | |
| Certificate | CE, RoHs | |
| Lamp Body Color | Cray(default with RAL9007)、Black(optional for RAL9005) | |
| Product Size (mm) | 441*374*50 | |
| Net weight (kg) ±0.1 | 6.37 | |
| Packing Size (mm) | 500*415*76 | |
| Gross weight (kg) ±0.1 | 6.84 | |
| Total Size (mm) (2pcs) | 520*170*440 | |
| Total weight (2pcs) ±0.2 | 14.43 | |
| Installation mode | Bracket Mount | |

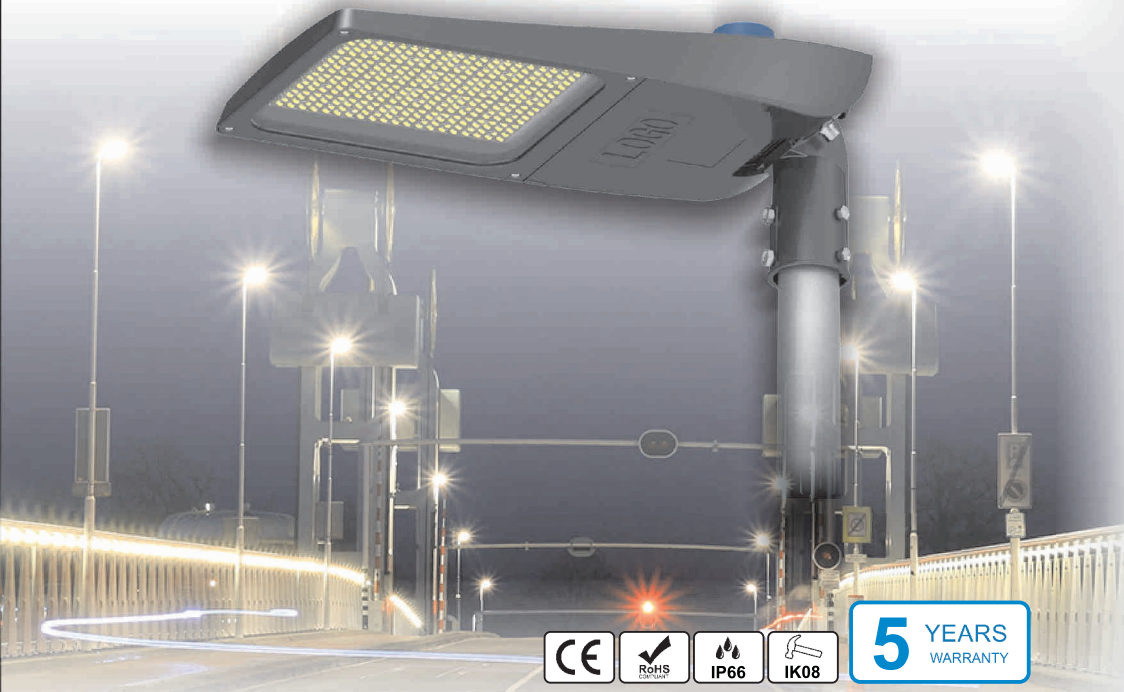

Features

- High Output LED's, up to 130~140lm/W
- Maintenance flap for quick access to the driver compartment
- Excellent heat dissipation and modern design
- Slim and compact profile for maximum wind resistance
- IP66 for all weather condition
- 3pin, 5pin, 7pin NEMA base
- Optional 20KV Surge Protection upgrade
- 5 years warranty

Applications

- Road Lighting

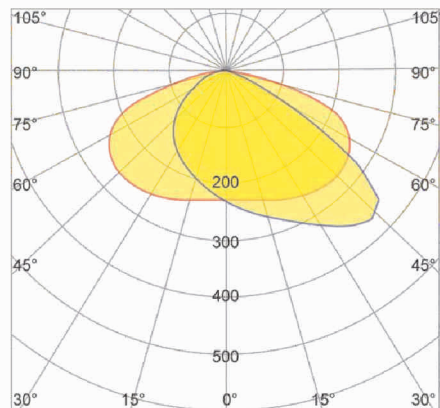
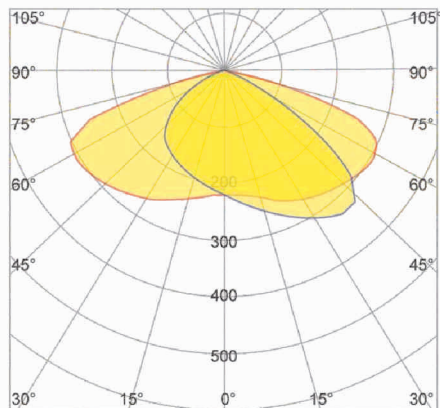

Smart LED Street Light

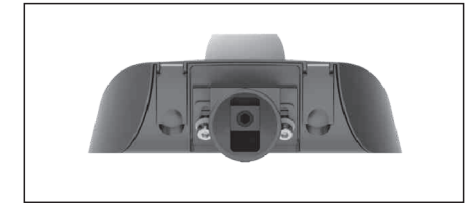
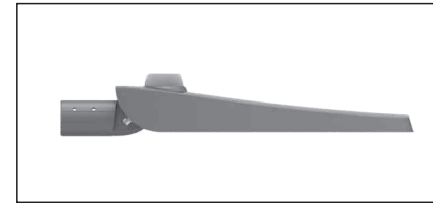
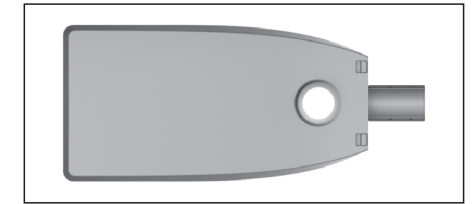
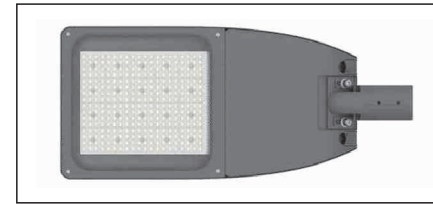

Specifications

| | | | |
|-------------------------------|-------------------------|-------------------------------------|-------------------------------------|
| Product Code | IT-SL-28/38/45/55/65W | IT-SL-75/90/105/120W | IT-SL-130/150/160/180W |
| Power | 28/38/45/55/65W | 75/90/105/120W | 130/150/160/180W |
| Input Voltage | 198-264VAC 50/60Hz | | |
| Input Current | 0.13/0.27A | 0.4A | 0.55/0.69/0.82A |
| PF | 0.95 | | |
| Control | PHILIPS | Photo cell, Zigbee, NB-IoT | |
| CCT | 3000K/4000K/5000K/5700K | | |
| Ra > 70, 5000K | Luminous Flux | 3920/5320/6300 7700/9100Lm ± 10% | 10500/12600/ 14700/16800Lm ± 10% |
| | Efficiency | 140Lm/W ± 10% | |
| LED Brand | LUMILEDS, CREE | | |
| Beam Angle | ME1~ME5 | | |
| Operation Temp | -40°C ~ +50°C | | |
| Storage Temp | -40°C ~ +85°C | | |
| Life Span | 50000Hours@L70 | | |
| IP Class | IP66 | | |
| IK Class | IK08 | | |
| Certificate | CE, CB, ENEC, RoHs | | |
| Lamp Body Color | RAL7024 | | |
| Product Size (mm) | 562*240*86mm | 624*313*106mm | 731*312*106mm |
| Net weight (kg) ±0.3 | 4.3 | 6.0 | 7.8 |
| Packing Size (mm) | 631*318*169mm | 700*390*190 | 800*390*190mm |
| Gross weight (kg) ±0.3 | 5.5 | 7.2 | 9.0 |
| Installation mode | Pendant Mount | | |

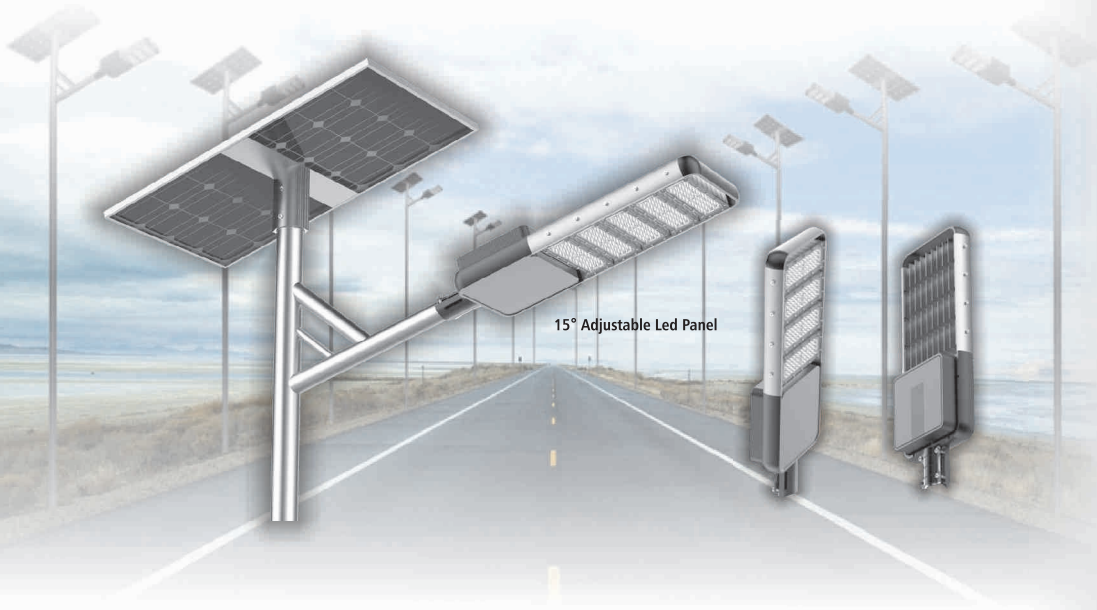

170LM/W High Efficiency Bridgelux Led Chip

- 100,000 hours Lifetime
- Bat-wing+Polarized lens, patented lens specially designed, better illumination uniformity improve light effect.

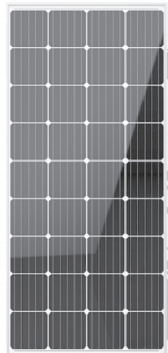

- Monocrystalline Silicon Solar Panel
- >21% Photoelectric conversion efficiency
- 25 years lifespan



- High efficiency conversion
- Intelligent design

*When the power is equal to or less than 40%, the power is automatically allocated to ensure that the duration of the lamp is on.

*When sundays, it can ensure the lighting power.

*When cloudy / rainy days, it can ensure the lighting time.

Semi-integrated Solar LED Lights

Solar Street Light Components

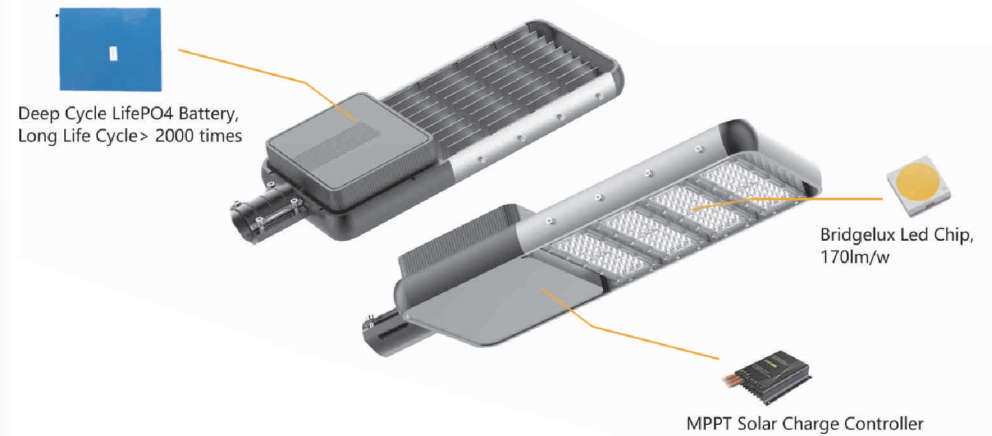

Features

- Patent Design
- Semi-integrated Solar LED Light
- Large Battery Capacity
- Adjustable LED panel
- High Brightness , 170lm/w
- OEM / ODM Available
- 3 Years Warranty

Applications

- Road Lighting



Specifications

| Model No | IT-SL-30W | IT-SL-40W | IT-SL-50W | IT-SL-60W | IT-SL-80W | IT-SL-100W | IT-SL-120W |
|-----------------------|-----------------------------------|---------------|---------------|---------------|---------------|---------------|---------------|
| Mono Solar Panel | 18V 40W | 18V 50W | 18V 65W | 18V 80W | 18V 100W | 18V 130W | 18V 170W |
| LifePO4 Batterie | 12.8V 18AH | 12.8V 24AH | 12.8V 30AH | 12.8V 36AH | 12.8V 42AH | 12.8V 54AH | 12.8V 60AH |
| Brightness | 5100LM | 6800LM | 8500LM | 10200LM | 13600LM | 17000LM | 20000LM |
| Mounting Height | 4-6m | 5-7m | 6-8m | 7-9m | 8-10m | 9-12m | 10-12m |
| Space between 2 lamps | 10-20m | 15-25m | 20-30m | 20-30m | 25-35m | 30-40m | 30-40m |
| Package Size | 695*300*115mm | 695*300*115mm | 695*300*115mm | 695*300*115mm | 785*300*115mm | 785*300*115mm | 785*300*115mm |
| Gross Weight | 4.6KG | 5.2KG | 6KG | 5.2KG | 7.5KG | 9KG | 9.6KG |
| Color Temperature | 2700-6500K | | | | | | |
| IP Rating | IP66 | | | | | | |
| Working Time | 12-15hours,5-7 cloudy/ rainy days | | | | | | |
| Charging Time | 6-8hours | | | | | | |
| Warranty | 3 years | | | | | | |

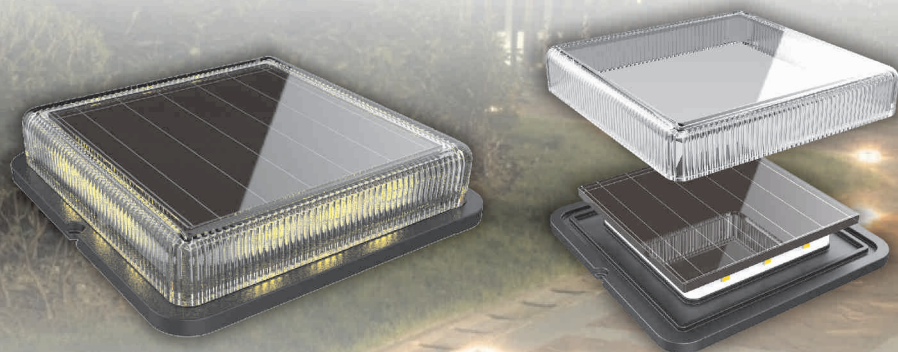

3 YEARS
WARRANTY

Dare to walk along a dark way like this?



Lighting can reduce the crime rate **39%**

By NYPD crime LAB, 2013

Installation

Mode 1

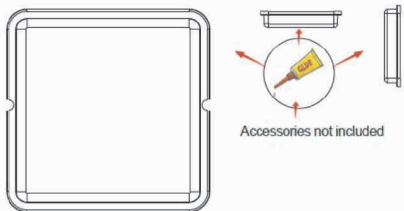

Simple installation with Waterproof Silicone Sealant Caulk stick on ground, no need screw to break into ground, note Sealant Caulk not included
1. Clean the ground
2. Paste the Waterproof Silicone Sealant Caulk onto the bottom of lamp, about 10g/10ml
3. Stick the lamp onto the ground, press to flat

Mode 2

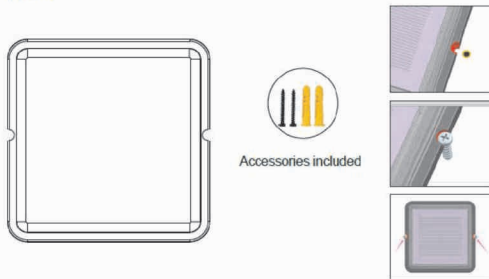

1. This light has a hole on two sides, screws are included for installation.
2. Select the right place, fix the screws into the holes.

LED Solar Ground Light

A Ground Light with Solar Energy can Solve all those Problems

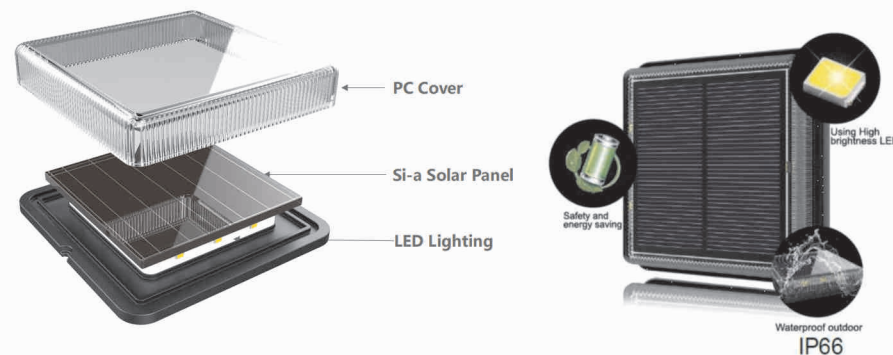

No electric wires needed, 4 hours sunshine can last nearly 12 hours

Features

- Simple installation with glue on ground, no need scerw to break into ground, note glue not included.
- This solar ground light is naturally charged by the sun.
- Light on automatically as soon as it starts getting dark and last for up to 12 hours.
- Ideal for illuminating paths, decks, docks, boats, driveways and roads.
- Effective,easy to install and require absolutely no wires or maintenance.
- 3 years warranty

Applications

- Plazas
- Parks
- Residential Areas
- Pedestrian Streets
- Hiking Trails

Specifications

| | |
|------------------------|-------------------------------|
| Model No | IT-SGL-0.60W |
| Input Power | 0.6W |
| Dimension | 110*110*22mm |
| CCT | 3000K / 4000K / 5000K / 6000K |
| CRI | Ra70 |
| LED BRAND | 2835 |
| IP | IP66 |
| Battery | 3.7V 600mAH Lithium Battery |
| Switch type | Light-sensitive |
| Charging menthod | Solar Powered |
| Lumens efficiency | 20-30LM |
| Surface color | Transparent+Black |
| Working Temp& Humidity | -25°C~55°C |
| Warranty | 3 years |
| Lifespan | 50,000hours |



5 YEARS WARRANTY

Product Benefits

Advantages:

- Die cast aluminum housing
- Toughed tempered glass
- Tool-less entry. Easy installation
- Mount Method: Ceiling mounted, wall mounted, Hanging etc.
- Luminaire secured with two mounting bolts standard
- Power Factor: >0.9 at full load
- Total Harmonic Distortion: <20% at full load
- Integral 10KV surge suppression protection standard

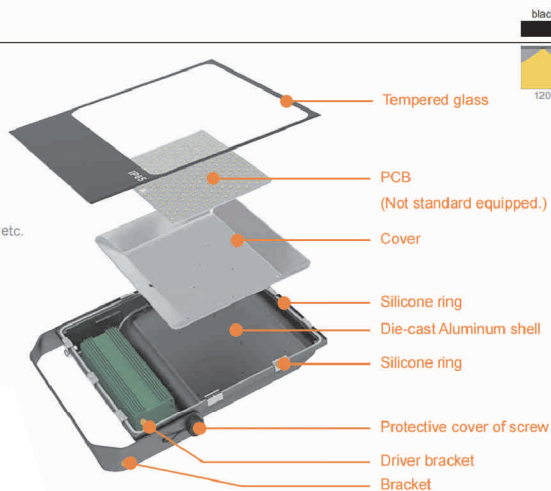

show details

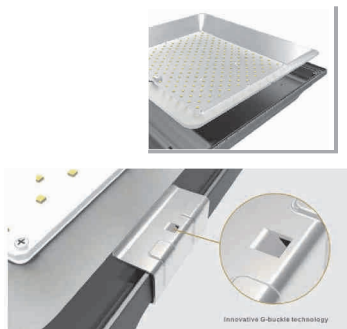

Lighting distribution chart

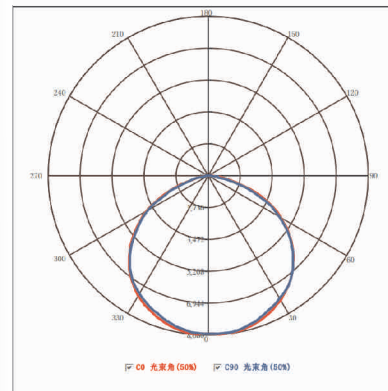

Color temperature

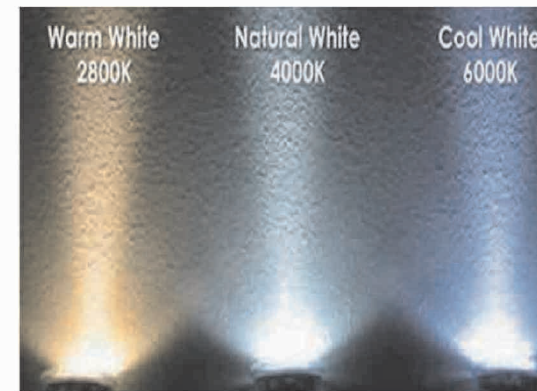

Features

- Durable High-impact 6063 Aluminum Alloy Shell
- Meanwell Driver
- IP65: Water-proof, Dust-proof
- 1-10V ,Dali dimming ,sensor available
- CE, RoHS Certificates
- 5 Years Warranty

Applications

- Bridge
- Billboard
- Road Lighting
- Any outdoor application

Specifications

| Model No | IT-FL50W | IT-FL80W | IT-FL100W | IT-FL150W | IT-FL200W |
|-----------------------------------|-----------------------------------------------------------|--------------|--------------|--------------|--------------|
| Input Power | 50W | 80W | 100W | 150W | 200W |
| Dimension | 311×220×48mm | 355×245×50mm | 403×295×54mm | 431×330×54mm | 471×360×54mm |
| CCT | 3000K / 4000K / 5000K / 6500K (2700K can be customized) | | | | |
| CRI | Ra70 /Ra80 | | | | |
| LED BRAND | Lumileds 3030 | | | | |
| Dimming | 1-10V ,Dali dimming | | | | |
| PF | >0.95 | | | | |
| IP Grade | IP65 | | | | |
| Input Voltage | 90-305VAC | | | | |
| Lumens efficiency | 130lm/w in CRI80 /140lm/w in CRI70 | | | | |
| Beam Angle | 120° | | | | |
| Working Temp& Humidity | -40°-45° & 20--95%RH No condensation | | | | |
| Installation Mode | Bracket Mount | | | | |
| Warranty | 5 years | | | | |
| Lifespan | 50,000hours | | | | |

- ☀ 100%
- ☀ 80%
- ☀ 60%



- 3000K
- 4000K
- 6500K

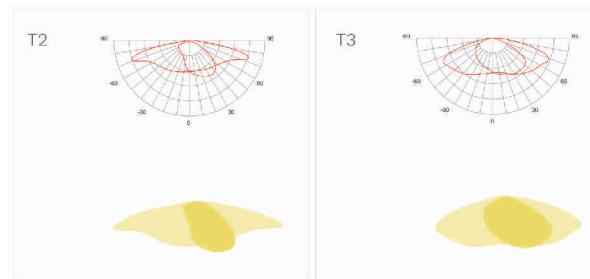
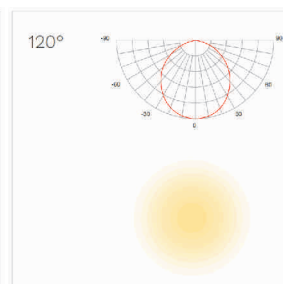
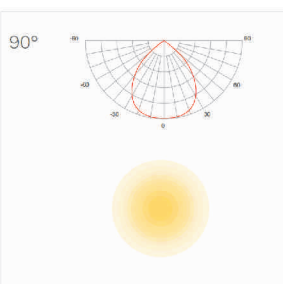
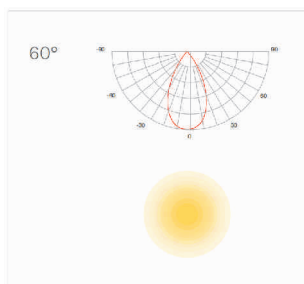
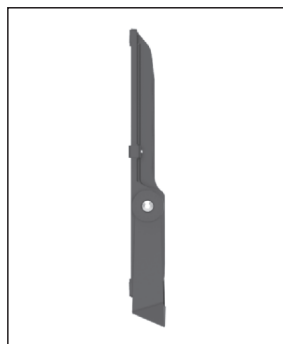

Features

- Come with CCT and Power selectable function, reduce the SKU and achieve greater light control and efficiency
- Pro Series can be matched with sensors to reduce energy consumption
- Perfect thermal management for long-term performance
- Wide choice of optics to suit more applications
- A cost-effective and very competitive solution offers an industry-leading lux and significant energy savings
- Various mounting options and inclination possibilities on-site for optimal photometry
- Tempered glass cover to effectively reduce UV damage on the lens
- Real beneficial LED alternative to HID floodlights for high-power applications
- Multiple power options with complete wattage

Applications

- industrial hall&warehouse
- sport facilities
- car parks
- large areas
- bridges
- tunnel&underpasses

Specifications

| Model No | IT-FL50W-PRO | IT-FL100W-PRO | IT-FL150W-PRO | IT-FL200W-PRO | IT-FL300W-PRO |
|--------------------------|--------------------------------|---------------|---------------|---------------|---------------|
| Input Power | 50W | 100W | 150W | 200W | 300W |
| Dimension | 375*290*100mm | 390*365*100mm | 445*390*100mm | 505*390*100mm | 670*475*125mm |
| CCT | 3000K/4000K/6500K | | | | |
| CRI | > 80 | | | | |
| PF | > 0.9 | | | | |
| IP Grade | IP66 | | | | |
| Input Voltage | 100-277V50/60Hz | | | | |
| Dimming Range | 100% ,80% ,60% | | | | |
| Lumens efficiency | 140lm/W,170lm/W | | | | |
| Beam Angle | 60° / 90° / 120° TYPE2 / TYPE3 | | | | |
| Working Temp | -30°C to + 45°C | | | | |
| Warranty | 5 years | | | | |
| Lifespan | 100,000hours | | | | |
| Mounting Option | Bracket Mounting | | | | |



5 YEARS WARRANTY

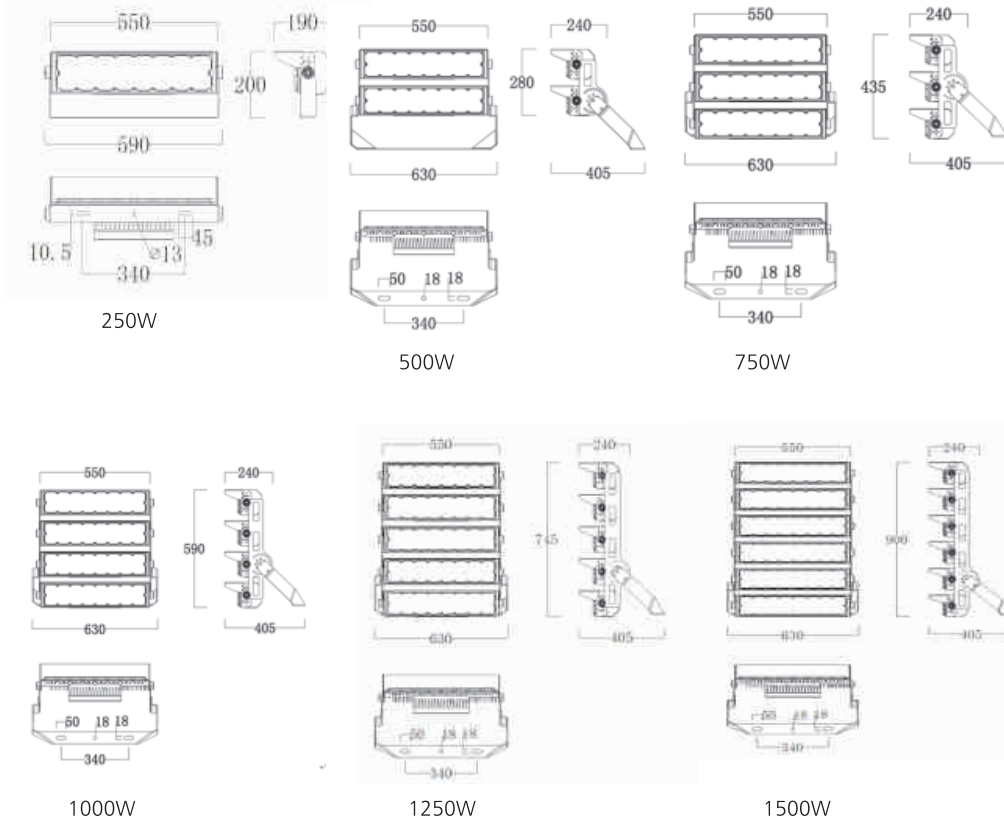

Wiring Diagram

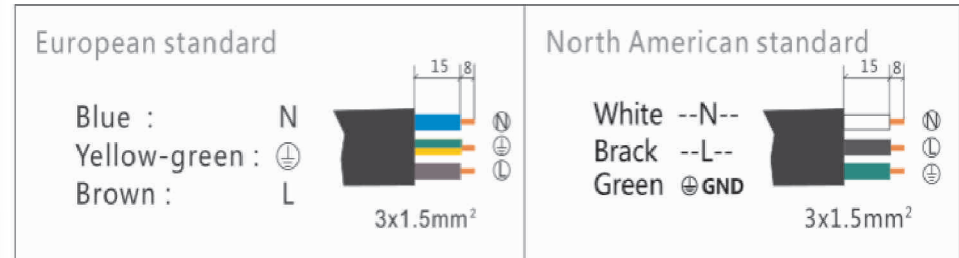

Features

- Features
- 250W ,500W,750W,1000W ,1250W ,1500W optional
- Up to 150 lm/W,energy saving
- IP65 for indoor and outdoor use under all conditions.
- Robust and modern design.
- Long lifetime due to high quality CREE & Lumileds LED chips and Meanwell drivers.
- 10KV Surge Protection.
- 5 Years warranty
- Certificate: CE,RoHs Certified

Applications

- Tennis Courts
- Baseball Stadiums
- Soccer Fields
- Golf Courses
- Racetracks
- Station

Specifications

| Model No | IT-SPL250W | IT-SPL500W | IT-SPL750W | IT-SPL1000W | IT-SPL1250W | IT-SPL1500W |
|--------------------------|-----------------------------------------|---------------|---------------|---------------|---------------|---------------|
| Input Power | 250W | 500W | 750W | 1000W | 1250W | 1500W |
| Dimension | 590*200*190mm | 630*240*350mm | 630*240*500mm | 630*240*660mm | 630*240*810mm | 630*240*950mm |
| CCT | 4000K / 5000K / 6000K | | | | | |
| CRI | Ra70 / Ra80 | | | | | |
| LED BRAND | Lumileds 3030 or Cree 3030 | | | | | |
| Dimming | 1-10V ,Dali dimming | | | | | |
| PF | >0.90 | | | | | |
| IP Grade | IP65 | | | | | |
| Input Voltage | A200-240 VAC(50/60Hz) | | | | | |
| Lumens efficiency | 140lm / w in CRI80 / 150lm / w in CRI70 | | | | | |
| Beam Angle | 10° /20° / 40°/60° / Tilt 50° | | | | | |
| Working Temp | -20°-45°C | | | | | |
| Installation Mode | Bracket Mount | | | | | |
| Warranty | 5 years | | | | | |
| Lifespan | 50,000hours | | | | | |



SUNLIKE LED
Close to pure daylight spectrum
Less visual fatigue

HIGH CRI
Better color recognition
Thanks to the benefit of advanced LED, clarity of the every detail piece is delicately portrayed.

CRI > 90 **CRI > 80**

VENUS Low CRI

LOW GLARE
Advanced Recessed reflectors

LED Chips
Holder
Secondary Optics
Anti-glaring parts

UGR < 13
• Less visual fatigue
• Higher working efficiency

ROTATABLE
Choose just right

180°

SPACE LIGHTING
Direct & indirect lighting combined
Create a homogeneous lighting

↑ 66W Indirect light
↓ 34W Direct light

CCT TUNABLE
Independent CCT tunable for up/down luminance

SENSING
Motion sensing
Max motion range: 7m

Micro dim & Daylight sensing

① Daylight sensing
various threshold value selectable

| | | | | | | | | | | |
|-----|-----|-----|-----|-----|-----|-----|-----|-----|-----|-----|
| 00% | 05% | 10% | 15% | 20% | 25% | 30% | 35% | 40% | 45% | 50% |
| 00% | 05% | 10% | 15% | 20% | 25% | 30% | 35% | 40% | 45% | 50% |

DETAILS

Reflector
Advanced recessed reflector, UGR < 13

Key switch
Power off by touch

Rotation AI
Storage provided for AI technology

Sturdy base
Up to 1.5kg stability for mobile computers



- Modern simplicity design
- Glare free with UGR < 13
- High CRI > 90
- 180° Rotatable light head , more flexible
- Sunlike LED equipped for better visual comfort and health
- Direct and indirect lighting combined
- CCT Tunable ,good for reading ,work & relax
- Motion and daylight sensing integrated
- Flicker free
- USB charging port ,good for office using
- 5 Year Warranty on complete fixture. (LED's, Driver, & Housing)
- Certificate: CE,RoHS Certified

KEY SWITCH
Easy & Clear

USB CHARGING

① Key switch
Power off by touch

② Daylight sensing
various threshold value selectable

③ CCT tunable
Independent CCT tunable for up/down luminance

④ Charging port
For USB charging

⑤ Motion sensing
Max motion range: 7m

⑥ Micro dim & Daylight sensing

⑦ Rotation AI
Storage provided for AI technology

⑧ Sturdy base
Up to 1.5kg stability for mobile computers

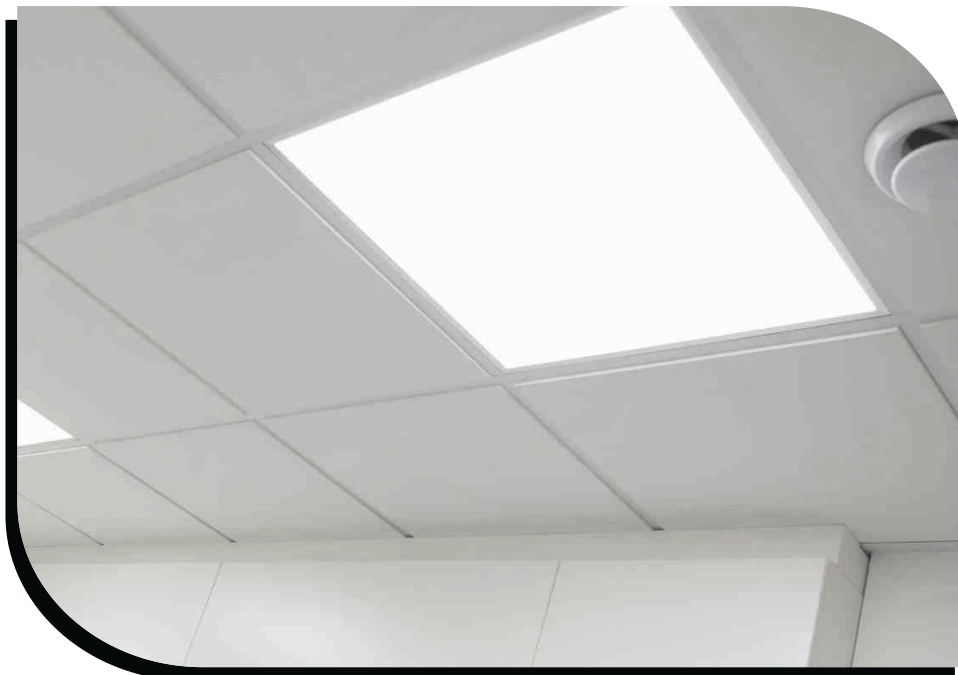

LED Square PANEL LIGHT

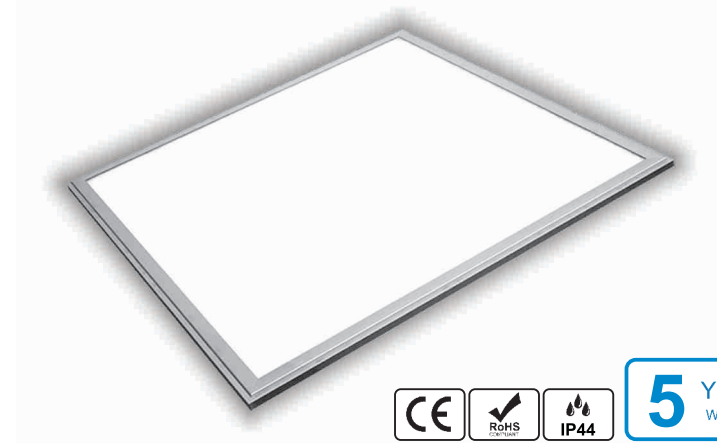

Features

- High Output LED's, up to 120-130lm/W, energy saving
- High CRI >85
- UGR < 19 is available
- With PMMA Light guide plate, anti-yellowing
- 11mm thickness aluminum frame, anti-deformation
- TUV UL CE SAA CB certificate, High PF > 0.96 low THD driver
- Flicker free
- Environmentally friendly, no mercury, No UV, No IR
- Polyester powder coated frame with white finish.
- 5 Year Warranty on complete fixture. (LED's, Driver, & Housing)

Applications

- Office Lighting
- School Lighting
- Healthcare Lighting
- Workshops
- Supermarkets

Specifications

| Model No | IT-6060-30W | IT-6060-40W | IT-123-30W | IT-123-40W | IT-126-60W |
|----------------------|--------------|-------------|---------------|------------|---------------|
| Input Power | 30W | 40W | 30W | 40W | 60W |
| Dimension | 595*595*11mm | | 1195*295*11mm | | 1195*595*11mm |
| CCT | 3000-6000K | | 3000-6000K | | |
| CRI | >82 | | >85 | | |
| Power Factor | >0.95 | | >0.95 | | |
| IP Grade | IP44 | | IP44 | | |
| Input Voltage | 200-240V | | 200-240V | | |
| Luminous | 120lm/W | | 110-120lm/W | | |
| SDCM | <3 | | <3 | | |
| Beam Angle | 120° | | 120° | | |
| Working Temp | -20°-50° | | -20°-50° | | |
| Warranty | 5 Years | | 5 Years | | |
| Lifespan | 50000H | | 50000H | | |

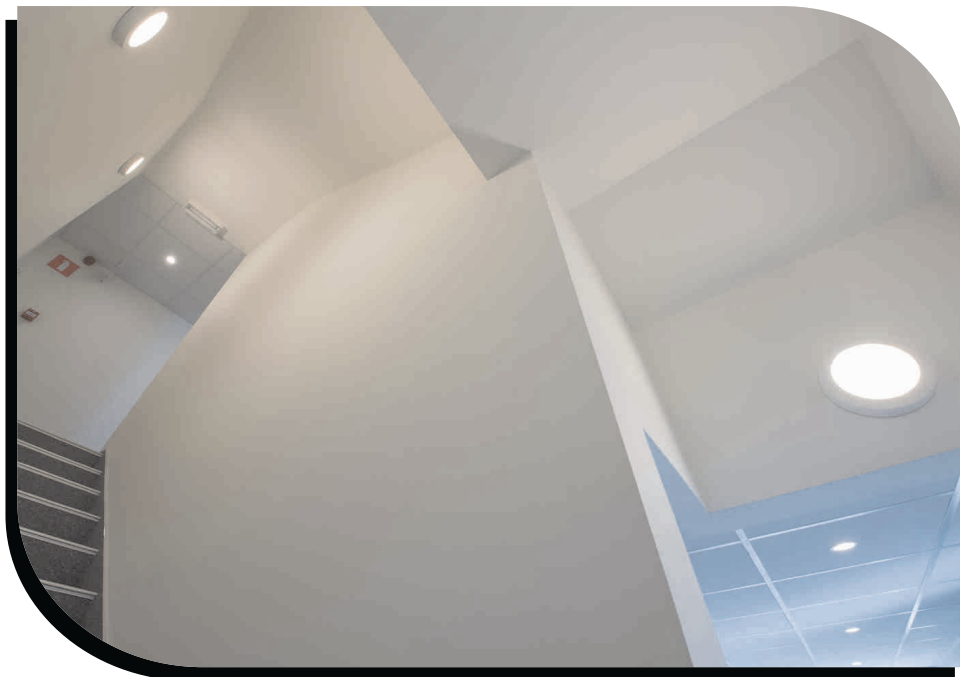
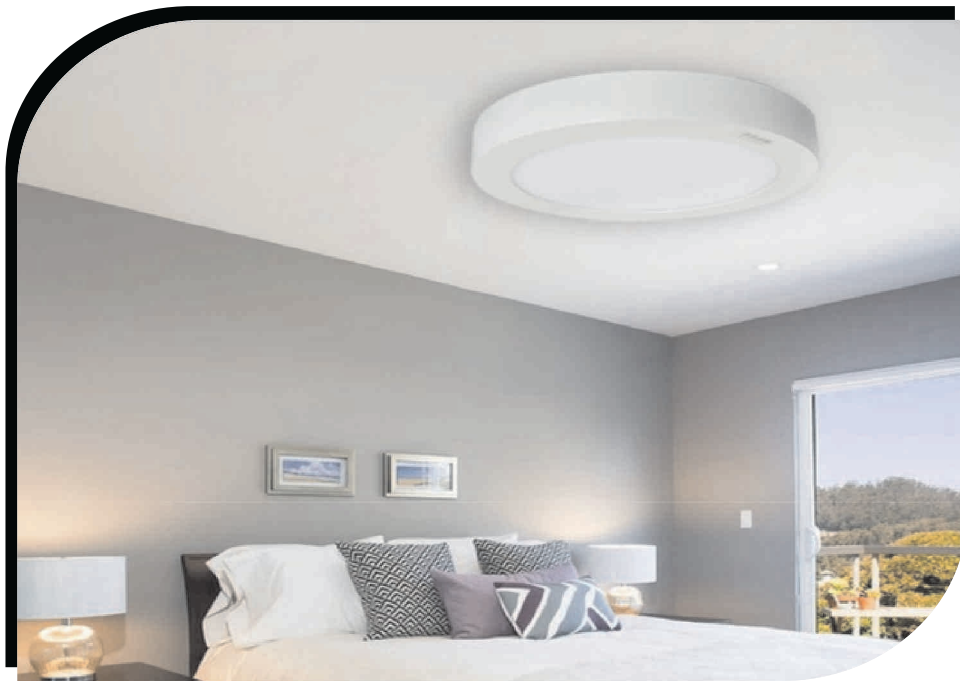

LED Round PANEL LIGHT



Features

- High Output LED's, up to 100lm/W, energy saving
- High CRI >85
- TUV UL CE SAA CB certificate, High PF>0.96 low THD driver
- Flicker free
- Environmentally friendly, no mercury, No UV, No IR
- Polyester powder coated frame with white finish.
- 5 Year Warranty on complete fixture. (LED's, Driver, & Housing)

Applications

- Office Lighting
- School Lighting
- Healthcare Lighting
- Supermarkets

Specifications

| Model No | IT-P145-8W | IT-P180-15W | IT-P240-18W | IT-P300-22W |
|------------------|---------------|---------------|---------------|---------------|
| Input Power | 8W | 15W | 18W | 22W |
| Dimension | 145x145x14 mm | 180x180x14 mm | 240x240x14 mm | 300x300x14 mm |
| Cut Out Size(mm) | 130mm | 160mm | 220mm | 280mm |
| CCT | 3000-6000K | | 3000-6000K | |
| CRI | >82 | | >85 | |
| Power Factor | >0.92 | | >0.92 | |
| IP Grade | IP44 | | IP44 | |
| Input Voltage | 200-240V | | 200-240V | |
| Luminous | 90-100lm/W | | 90-100lm/W | |
| LEDs QTY | 48PCS | 72PCS | 96PCS | 120PCS |
| Beam Angle | 120° | | | |
| Working Temp | -20°-50° | | | |
| Warranty | 5 Years | | | |
| Lifespan | 50000H | | | |



RGBW LED Panel Lights



Features

- 4 kinds of color available for one LED.19:19
- 20 colors is optional,one more separate white color which is perfect for indoor lighting.
- CCT:2800-3200K,4000-4500K,6000-6500K available.
- Support dimmable function-dimming range: 25%-100%.
- Compatible with IR/Wireless/Bluetooth/DMX control system.E19

Applications

- Office Lighting
- School Lighting
- Workshops
- Supermarkets

Specifications

| Model No | IT-PL-6060-45W-RGBW | IT-PL-6262-48W-RGBW | IT-PL-30120-45W-RGBW | IT-PL-60120-54W-RGBW |
|----------------|--------------------------------|---------------------|----------------------|----------------------|
| Input Power | 45W | 48W | 45W | 53W |
| Product Size | 595*595*11mm | 620*620*11mm | 295*1195*11mm | 595*1195*11mm |
| LED Qty | 196*SMD5050 | 210*SMD5050 | 196*SMD5050 | 210*SMD5050 |
| CCT | 3000K4000K6000K | | | |
| CRI | 80 | | | |
| Input Voltage | AC85~265V50/60HZ | | | |
| Output Voltage | DC24V | | | |
| Beam Angle | >160° | | | |
| Material | Aluminum+ PMMA LGP+PS Diffuser | | | |
| Working Temp | -20°-50° | | | |
| Warranty | 3 Years | | | |



Screwless Surface Mounting Frame

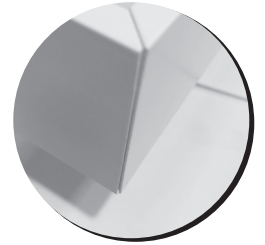

Features

- Screwless design, Easy installation, Labor costs saving.
- 300x300mm; 300x600mm; 600x600mm; 620x620mm; 1200x300mm and 1200x600mm available.
- White & Silver Frame available.
- 1mm thickness, Anti-deformation
- Customized size available
- Independent inner package ,better for resale

Applications

- Panel Light Installation

intergrated surface mounting frame



screwless recessed ceiling frame

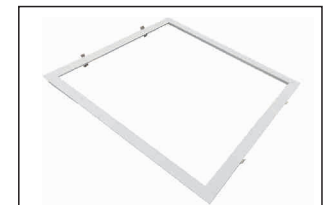



Moon Series Low UGR LED Down Light

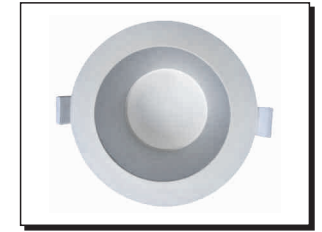

Features

- Suitable to replace 2x35w CFL
- UGR<19 ,friendly to your eyes
- Light source can be 140lm/w, complete Luminaire is 80-100lm/w
- SDCM<3 THD<15
- 5 YEARS WARRANTY

Applications

- Public rooms and areas
- Stairways
- Corridors
- Foyers
- Shops

Specifications

| Model No | IT-DL-2.5"-6W-M | IT-DL-3"-10W-M | IT-DL-4"-15W-M | IT-DL-6"-30W-M | IT-DL-8"-40W-M |
|-------------------|-----------------|----------------|----------------|----------------|----------------|
| Input Power | 6W | 10W | 15W | 30W | 40W |
| Product Size | D90mm*H58mm | D102mm*H68mm | D140mm*H68mm | D180mm*H90mm | D230mm*H120mm |
| Cut out size (mm) | 75mm | 90mm | 120mm | 150mm | 200mm |
| CCT | 3000-6000K | | | | |
| CRI | 80/90 | | | | |
| Input Voltage | 220-240V AC | | | | |
| Lumens Efficiency | 80-100lm/W | | | | |
| Beam Angle | 70° | | | | |
| Working Temp | -20°-50° | | | | |
| Warranty | 5 Years | | | | |
| Lifespan | 50000H | | | | |



Moon series Glare free LED track light

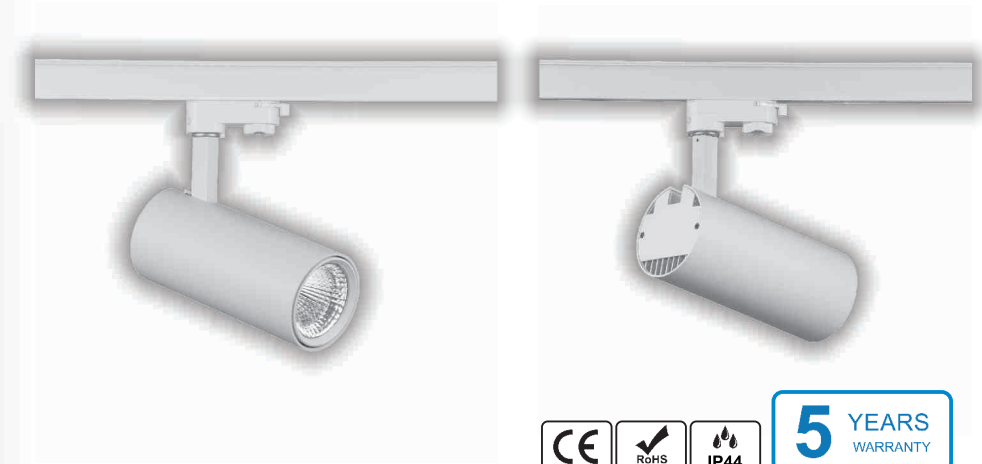

Features

- Elegant design ,excellent heat dissipation
- Citizen COB, world famous brand
- High CRI 90 or C97 is available
- UGR<19 anti- glare, friendly to your eyes
- SDCM<3
- Boke brand driver, Flicker free
- 5 Year Warranty

Applications

- Shopping mall
- Museum
- Art exhibition
- Retail

Specifications

| Model No | IT-LTL-20W-M | IT-LTL-30W-M | IT-LTL-40W-M |
|------------------|-------------------------------------|--------------|--------------|
| Input Power | 20W | 30W | 40W |
| Dimension | Φ80*155mm | Φ90*200mm | Φ90*200mm |
| Light Source LED | Citizen | | |
| CCT | 2700K/3000K/3500K/4000K/5000K/6000K | | |
| CRI | 80/90/97 | | |
| Beam Angle | 15°, 24°,38° | | |
| IP Grade | IP44 | | |
| PF | >0.9 | | |
| Input Voltage | 220~240VAC | | |
| Luminous | CRI80:100-110lm/W CRI90:90-100lm/w | | |
| Driver | Boke flicker driver | | |
| Working Temp | -20~+45°C | | |
| Warranty | 5years | | |
| Lifespan | 50,000H | | |



Eco Series LED Linear Track Light

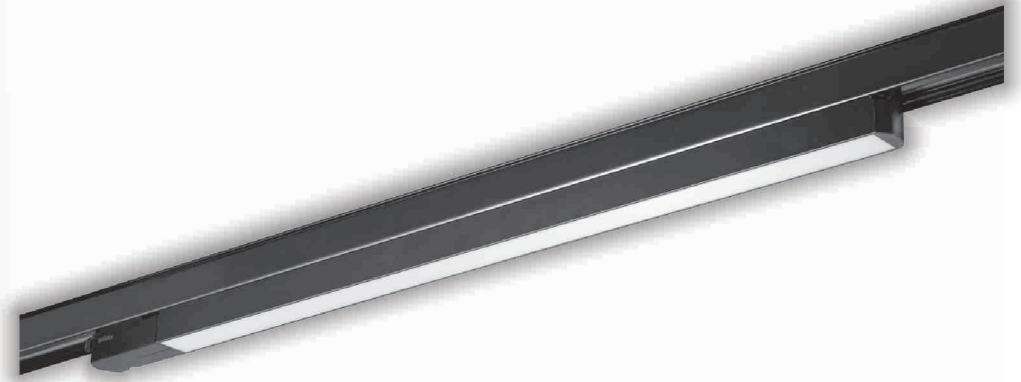

3 YEARS
WARRANTY

Features

- Up to 100lm/w ,energy saving
- Elegant design ,excellent heat dissipation
- Samsung LED , world famous brand
- High CRI 90 is available
- SDCM <3
- Flicker free
- 3 Year Warranty

Applications

- Office lighting
- Shop lighting
- School lighting

Specifications

| | | |
|--------------------------|-------------------------------|---------------------|
| Model No | IT-LTL-2F-20W-C | IT-LTL-4F-30W-C |
| Input Power | 20W | 30W |
| Dimension | L600 * W48* H31mm | L1200 * W48* H31mm |
| Lumens efficiency | 100LM/W at CRI 80 | 80-90LM/W at CRI 90 |
| Light Source LED | Samsung | |
| CCT | 2700K/3000K/3500K/4000K/5000K | |
| CRI | 80/90 | |
| Beam Angle | 120° | |
| PF | >0.9 | |
| Input Voltage | 220~240VAC | |
| Warranty | 3 years | |

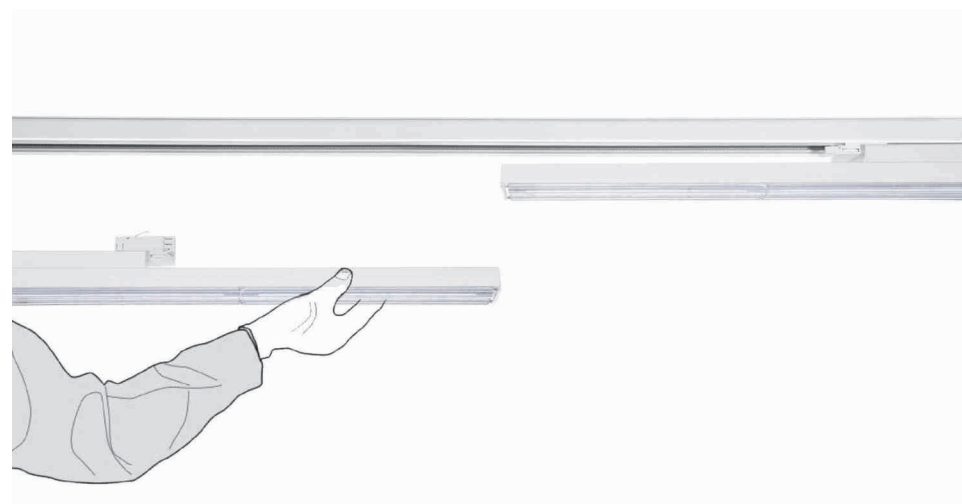
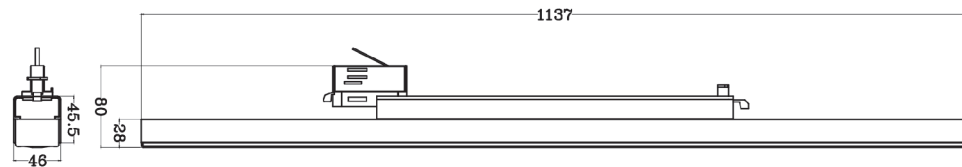

Continuous LED Linear Track Light



Features

- Using PHILIPS chip, Up to 130lm/w
- Advanced design LEDiL lens, with first-rate lighting control effect
- High CRI 90 is available
- UGR<19 optional
- SDCM<3
- Boke driver ,Flicker free
- Patent design ,46mm width,more compatible with track rail
- Easy installation ,labor cost saving

Applications

- Super market
- Museum
- Retails Stores
- Office

Specifications

| | | |
|--------------------------|-------------------------------------------------|--------------------|
| Model No | IT-LTL-4F-50W-A | IT-LTL-4F-60W-A |
| Input Power | 50W | 60W |
| Dimension | L1137* W46 * H28mm | L1137* W46 * H28mm |
| Light Source LED | PHILIPS | |
| CCT | 2700K/3000K/3500K/4000K/5000K | |
| CRI | 80/90 | |
| Beam Angle | 60° / 90°/ Asymmetric 25°/Double Asymmetric 25° | |
| PF | >0.9 | |
| Input Voltage | 220~240VAC | |
| Lumens efficiency | 130lm/W | |
| Lens | LEDiL | |
| Driver | BOKE | |
| Warranty | 5 years | |